



Visit www.clevelandrange.com to locate a service or sales representative in your area.

Cleveland

Skillets

Tabletop Electric Skillets

Operation, Installation & Maintenance Manual

This manual is updated as new information and models are released. Visit our website for the latest manual.

MODELS:

SET-10

For your future reference.

Model # _____

Serial # _____



***Read the manual thoroughly.
Improper installation, operation or
maintenance can cause property
damage, injury, or death.***

Part # KE004018-2 Rev C
April 2024

STATEMENT OF RESPONSIBILITIES / DÉCLARATION DES RESPONSABILITÉS / DECLARACIÓN DE RESPONSABILIDADES

This document is for use by experienced and trained Qualified Cleveland Range, LLC Authorized Service Representatives who are familiar with both the safety procedures, and equipment they service. Cleveland Range, LLC assumes no liability for any death, injury, equipment damage, or property damage resulting from use of, improper use of, or failure to use the information contained in this document. Cleveland Range, LLC has made every effort to provide accurate information in this document but cannot guarantee that this document does not contain unintentional errors and omissions.

The information in this document may be subject to technical and technological changes, revisions, or updates. Cleveland Range, LLC assumes no liability or responsibility regarding errata, changes, revisions, or updates.

Qualified Cleveland Range, LLC Authorized Service Representatives are obligated to follow industry standard safety procedures, including, but not limited to, OSHA regulations, and disconnect / lock out / tag out procedures for all utilities including steam, and disconnect / lock out / tag out procedures for gas, electric, and steam powered equipment and / or appliances.

All utilities (gas, electric, water and steam) should be turned OFF to the equipment and locked out of operation according to OSHA approved practices during any servicing of Cleveland Range equipment.

Qualified Cleveland Range, LLC Authorized Service Representatives are obligated to maintain up-to-date knowledge, skills, materials, and equipment.

Ce document est destiné à l'usage des Représentants de Service qualifiés et autorisés de Cleveland Range, LLC qui possèdent l'expérience et la formation ainsi que la bonne connaissance des mesures de sécurité et du matériel qu'ils entretiennent.

Cleveland Range, LLC décline toute responsabilité pour tout cas de décès, blessure, dommage matériel ou dommage aux biens résultant de l'utilisation, de la mauvaise utilisation ou du manquement d'utilisation des renseignements contenus dans ce document.

Cleveland Range, LLC s'est efforcé à fournir des renseignements précis dans ce document mais ne peut garantir que ce document soit exempt d'erreurs et d'omissions non intentionnelles.

Les renseignements contenus dans ce document peuvent être assujettis à des changements techniques et technologiques, des révisions ou des mises à jour.

Cleveland Range, LLC décline toute obligation ou responsabilité concernant les errata, modifications, révisions ou mises à jour.

Les Représentants de Service qualifiés et autorisés de Cleveland Range, LLC sont tenus de se conformer aux mesures de sécurité normalisées de l'industrie, y compris, mais sans s'y limiter, les réglementations de l'OSHA, les procédures de débranchement / verrouillage / étiquetage relatives à tous les services publics, dont l'approvisionnement en vapeur, et les procédures de débranchement / verrouillage / étiquetage relatives aux équipements et/ou appareils fonctionnant au gaz, à l'électricité et à la vapeur.

Au cours de tout entretien d'un appareil Cleveland Range, tous les services publics (gaz, électricité, eau et vapeur) doivent être FERMÉS au niveau de l'appareil et le dispositif de fonctionnement doit être verrouillé suivant les pratiques approuvées de l'OSHA.

Les Représentants de Service qualifiés et autorisés de Cleveland Range, LLC sont tenus d'actualiser en permanence leurs connaissances, compétences, matériel et équipement.

Este documento está destinado para el uso de los Representantes de Servicio calificados y autorizados de Cleveland Range, LLC quienes cuentan con la experiencia y la capacitación, así como el buen conocimiento de las medidas de seguridad y de los equipos que mantienen.

Cleveland Range, LLC, declina toda responsabilidad en caso de cualquier fallecimiento, lesiones, daños al equipo o daños a la propiedad resultantes de la utilización, del uso indebido o de la falta de utilización de la información provista en este documento.

Cleveland Range, LLC se ha esforzado en suministrar información precisa en este documento, pero no puede garantizar que este documento esté exento de errores y de omisiones no intencionales.

La información contenida en este documento podría estar sujeta a cambios técnicos o tecnológicos, revisiones o actualizaciones. Cleveland Range, LLC declina toda obligación o responsabilidad con respecto a erratas, modificaciones, revisiones o actualizaciones.

Los Representantes de Servicio calificados y autorizados de Cleveland Range, LLC tienen la obligación de seguir los procedimientos estándar de seguridad de la industria; los cuales incluyen pero no se limitan a los reglamentos de la OSHA (La Administración de la Seguridad y Salud Ocupacionales), los procedimientos de desconexión, cierre y etiquetado relativos a todos los servicios públicos incluyendo el suministro de vapor y los procedimientos de desconexión, cierre y etiquetado para los equipos y/o aparatos que funcionan a base de gas, electricidad o vapor.

Cuando se esté dando servicio o mantenimiento a un aparato de Cleveland Range, todos los servicios públicos (gas, electricidad, agua y vapor) deben estar APAGADOS para el equipo en cuestión y se debe seguir el procedimiento de cierre de operaciones de acuerdo con las prácticas aprobadas por la OSHA.

Los Representantes de Servicio calificados y autorizados de Cleveland Range, LLC tienen la obligación de actualizar constantemente sus conocimientos, destrezas, materiales y equipamiento.

**FOR YOUR SAFETY / POUR VOTRE SÉCURITÉ /
PARA SU SEGURIDAD**

FOR YOUR SAFETY

Do not store or use gasoline or any other flammable liquids and vapours in the vicinity of this or any other appliance.

WARNING: Improper installation, operation, adjustment, alteration, service, or maintenance can cause property damage, injury or death. Read the installation and operating instructions thoroughly before installing, operating, or servicing this equipment.

Do not spray aerosols in the vicinity of this appliance while it is in operation.

This appliance is not to be used by persons with reduced physical, sensory, or mental capabilities, or lack of experience and knowledge, unless they have been given supervision or instruction concerning use of the appliance by a person responsible for their safety.

This appliance is not for use by children, and they must be supervised not to play with it.

Retain this manual for your reference.

POUR VOTRE SÉCURITÉ

Ne pas entreposer ou utiliser d'essence ou d'autres liquides ou vapeurs inflammables à proximité de cet appareil ou de tout autre appareil.

AVERTISSEMENT : Toute mauvaise pratique en matière d'installation, de fonctionnement, de réglage, de modification, d'entretien ou de maintenance peut causer des dommages matériels, des blessures ou la mort. Lisez la totalité des instructions d'installation et d'utilisation avant d'installer, d'utiliser ou d'entretenir cet équipement.

Ne pas pulvériser des aérosols dans le voisinage de cet appareil alors qu'il est en fonctionnement.

Cet appareil ne doit pas être utilisé par des personnes dont les capacités physiques, sensorielles ou mentales sont réduites, ou des personnes dénuées d'expérience ou de connaissance, sauf si elles ont pu bénéficier, par l'intermédiaire d'une personne responsable de leur sécurité, d'une surveillance ou d'instructions préalables concernant l'utilisation de l'appareil.

Conservez ce manuel pour votre référence.

PARA SU SEGURIDAD

No guarde ni use gasolina o cualesquiera otros líquidos o vapores inflamables en las cercanías de éste o cualquier otro aparato.

ADVERTENCIA: La indebida instalación, operación, ajuste, modificación, servicio o mantenimiento puede ocasionar daños a la propiedad, lesiones o muerte. Lea detenidamente las instrucciones de instalación y de operación antes de instalar, poner a funcionar o dar servicio a este equipo.

No pulverice aerosoles en las proximidades de este aparato mientras está en funcionamiento.

Este aparato no debe ser utilizado por personas con capacidades físicas, sensoriales o mentales reducidas, o que no tengan la experiencia y los conocimientos adecuados, a menos que estas personas hayan recibido supervisión e instrucciones en cuanto al uso del aparato por la persona responsable de la seguridad de ellas.

Guarde este manual para su referencia.

WARNING / AVERTISSEMENT / ADVERTENCIA

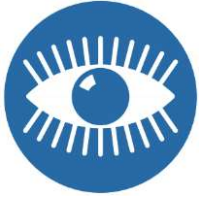

Inspect unit daily for proper operation. / Inspecter le bloc quotidiennement pour garantir le fonctionnement normal. / Inspeccione diariamente el funcionamiento correcto de la unidad.



Heavy. / Lourd. / Pesado.

Team or mechanical lift. / Levage en équipe ou mécanique. / Levantamiento en equipo o mecánico.



Surfaces may be extremely hot! Use protective equipment. / Les surfaces peuvent être extrêmement chaudes ! Utiliser des équipements de protection. / ¡Las superficies pueden estar muy calientes! Utilice equipo protector.



Do not climb, sit, or stand on equipment. / Il ne faut pas monter, s'asseoir ni se tenir debout sur l'équipement. / No subirse, ni sentarse ni pararse sobre el equipo.



Do not lean on or place objects on lip. / Ne vous penchez pas sur oune placez pas des objets sur la lèvre. / No se apoye ni coloque objetos en el labio.



Keep hands away from moving parts and pinch points. / Tenir les mains à l'abri des pièces mobiles et des angles. / Mantenga las manos lejos de las piezas móviles y los puntos de presión.



Hot product and surfaces. / Produit et surfaces chaudes. / Producto y superficies calientes.



Do not touch. / Ne pas toucher. / No la toque.

Appliance must not be supplied through an external switching device that is regularly switched on and off. / L'appareil ne doit pas être alimenté par un interrupteur externe régulièrement allumé et éteint. / El aparato no debe ser alimentado a través de un dispositivo de conmutación externo que se encienda y apague periódicamente.



Unit must be anchored as per manual. / Unité doit être ancrée selon les directives du manuel. / Unidad debe estar fijado según el manual.



Floor may become slippery from product spillage. / Déversement de produit peut causer de plancher à être glissant. / Derrame de producto puede causar piso a ser resbaladizo.



Have a qualified service technician maintain your equipment. / Demandez à un technicien en entretien et en réparation qualifié d'effectuer l'entretien de votre équipement. / Haga que un técnico de servicio calificado mantenga su equipo.



Shut off power at main fuse disconnect prior to servicing. / Couper l'alimentation sur le principal fusible sectionneur avant l'entretien. / Apague la alimentación eléctrica en el fusible desconector principal antes de darle servicio.



Stand clear of product discharge path when discharging hot product. / Écartez-vous du chemin de décharge d'un produit chaud. / Permanezca alejado de la ruta de descarga del producto al vaciar producto caliente.

**OPERATION, INSTALLATION & MAINTENANCE MANUAL SKILLET MODELS
SET-10**

INSTALLATION	5
GENERAL INFORMATION.....	5
RECEIVING INSPECTION	5
SHIPPING DAMAGE INSTRUCTIONS	5
UNCRATING	5
VENTILATION	5
CLEARANCE REQUIREMENTS.....	5
POSITIONING	6
ELECTRICAL CONNECTION	6
INSTALLATION CHECK.....	6
OPERATING INSTRUCTIONS	7
OPERATING INSTRUCTIONS	7
TEMPERATURE APPLICATION CHART	7
QUICK START GUIDE FOR EASYDIAL CONTROLS (SET-10)	8
CLEANING INSTRUCTIONS	13
CARE AND CLEANING	13
WARNING	13
CLEANING INSTRUCTIONS.....	13
DISPOSAL INSTRUCTIONS	13
PREVENTATIVE MAINTENANCE	14
DAILY PRE-STARTUP INSPECTION	14
SIX MONTH SERVICE INSPECTION	14
YEARLY SERVICE INSPECTION.....	14
TROUBLESHOOTING AND MAINTENANCE PROCEDURES	15
DIAGNOSTIC GUIDE	15
HEATING ELEMENT REMOVAL.....	15
HEATING ELEMENT BLOCK TORQUING	15
CALIBRATION INSTRUCTIONS	15

INSTALLATION

GENERAL INFORMATION

These instructions must be retained by the owner/user for future reference.

The serial plate is located on the right side of the control housing. Voltage, phase, amperage and wattage are stated on the plate.

This equipment is built to comply with applicable standards for manufacturers. Included among those approval agencies are: UL, A.G.A., NSF, ASME/N.Bd., CSA, CGA, ETL, and others. Many local codes exist, and it is the responsibility of the owner/installer to comply with these codes.

Check the electrical rating label to ensure that the unit is the correct voltage, phase, amperage, and wattage are stated on this label.

Observe all clearance requirements to provide air supply for proper operation, as well as sufficient clearance for servicing. Keep the skillet area free and clear of combustibles. Dimensions and clearance specifications are shown on the specification sheet.

WARNING: Installation of skillet must be accomplished by qualified installation personnel, working to all applicable local and national codes. Improper installation of product could cause injury or damage and void the warranty.

Installation must be in accordance with local codes and/or the National Electric Code ANSI/NFPA No. 70-latest edition (USA) or the Canadian Electrical Code CSA Standard C22.1 (Canada).

The skillet must be electrically grounded by the installer. Electrically powered skillets require a separate fused disconnect switch which must be supplied and installed in the high voltage electrical supply line. The wire gauge size and electric supply must match the power requirements specified on the skillet's rating plate. The conduit-enclosed permanent copper wiring must be adequate to carry the required current at rated voltage. Refer to the specification sheet for electrical specifications and location of electrical connections.

RECEIVING INSPECTION

Before unpacking visually inspect the unit for evidence of damage during shipping. If damage is noticed, do not unpack the unit, follow shipping damage instructions.

SHIPPING DAMAGE INSTRUCTIONS

If shipping damage to the unit is discovered or suspected, observe the following guidelines for a shipping damage claim.

1. Write down a description of the damage or the reason for suspecting damage as soon as it is discovered. This will help in filling out the claim forms later.
2. As soon as damage is discovered or suspected, notify the carrier that delivered the shipment.
3. Arrange for the carrier's representative to examine the damage.

4. Fill out all carrier claims forms and have the examining carrier sign and date each form.

APPROXIMATE WEIGHTS

Model #	Unit	Unit with shipping box
SET-10	160 lbs.	200 lbs.



UNCRATING

⚠ CAUTION:

Straps are under tension and will snap when cut. Carton may contain staples and skid contains nails. Use proper safety equipment and precautions. Unit is heavy. Use adequate help or lifting equipment as needed.

1. Carefully remove unit from shipping carton. Remove any packing material from unit. After carefully unpacking check for "concealed" damage. If damage is noticed, follow "Shipping Damage Instructions" shown below.
2. Check the electrical rating label to ensure that the unit is the correct voltage, phase, amperage and wattage are stated on this label.
3. A protective material has been applied to the stainless-steel panels. This material must be removed immediately after installation, as heat will melt the material and make it more difficult to remove.

VENTILATION

Operation of these units can produce significant levels of steam and condensate; it is recommended they be installed under a ventilation hood in a room which has provisions for adequate make up air. Further information can be obtained by referring to the U.S.A. National Fire Protection Associations NFPA96 regulations. These standards have also been adopted by the National Building Code in Canada.

CLEARANCE REQUIREMENTS

This unit must be installed in accordance with the following clearances to provide proper operation and servicing of the appliance. Also, it is recommended the unit be installed with sufficient clearances to provide proper cleaning and maintenance.

SET-10 - RIGHT: 3", LEFT: 0", REAR 1"

POSITIONING

1. Set skillet in position where electrical services are nearby. Comply with clearances stated on the specification sheet. Ensure there is sufficient clearance between the skillet and back wall.
2. Table-top models must be positioned on a firm, level stand or existing countertop, and bolted in place, using the four 5/16"-18 rods and nuts included with the skillet. These models are supplied with four 5/16"-18 weldnuts welded to underside of the base as illustrated below.

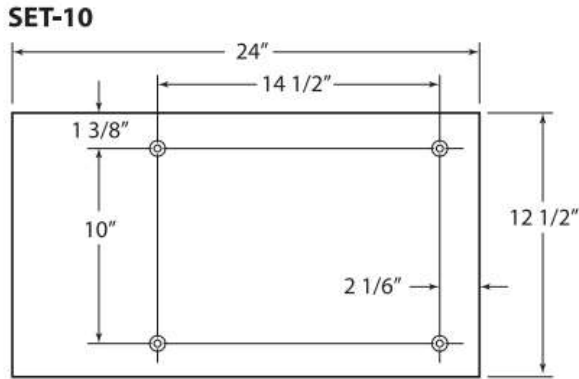

3. Make four 3/8" holes in an existing stand or countertop, in order to secure the base of the skillet. Once the holes are made, screw the threaded rods into the ferrules on the bottom of the skillet base. Then insert the threaded rods through the holes on the stand or countertop.
4. Thread the nuts onto the threaded rod and tighten to secure base. Once secure and level, apply a seal of silicon, to the entire edge of the base at the countertop. This will prevent food particles from entering underneath the skillet base. Screw the tilt handle into the threaded mounting block welded to the side of the skillet.

ELECTRICAL CONNECTION

FUSED DISCONNECT

A separate fused disconnect (supplied by installer) is required for this equipment.

WIRE CONNECTION

Remove the screws at the console cover and remove the cover. A wiring diagram is affixed to the underside of the cover. Feed conduit enclosed permanent copper wiring through the cut-out in the rear of the console and fasten to the three-connection terminal block. Be sure to connect the ground wire to the separate ground terminal connector (ground lug). Replace the console cover and secure it with the screw.

INSTALLATION CHECK

Although the skillet has been thoroughly tested before leaving the factory, the installer is responsible for ensuring the proper operation of the skillet once installed.

1. Ensure that the electric supply to the skillet is turned on.
2. Remove the lift-off cover.
3. Push ON/OFF switch to turn the unit ON.
4. Adjust Settings to Cook/On. Exit Settings. Push Temperature to select temperature. Turn Selector Dial to set at 425°F. Push Temperature to start the cooking cycle with heating contactors energizing immediately. Let the unit cycle ON/OFF at least three times.
5. Pour 2 gallons (8 liters) of cool tap water into preheated skillet pan.
6. It should take approximately 3 minutes for the water to begin to simmer. Shortly, the water should be bubbling uniformly across the entire cooking surface.
7. Turn Selector Dial to OFF.
8. Tilt skillet to drain the water out of the skillet pan, into an appropriate pan or other container.
9. Lower the skillet, then push ON/OFF switch to turn the unit OFF.

OPERATING INSTRUCTIONS



⚠ CAUTION:

If for any reason this unit is not functioning correctly, **DO NOT OPERATE.** Contact your authorized service agent.

OPERATING INSTRUCTIONS

1. Perform daily startup inspection (See *Daily Pre-Startup Inspection* in *Preventative Maintenance*).
2. Ensure that the electrical supply to the skillet is turned on.
3. Before cooking, be sure that the skillet's cooking surface is clean, and that the skillet is in the fully lowered position.
4. Turn ON the unit.
5. Pre-heat skillet for approximately 10 minutes to the desired temperature setting (see TEMPERATURE APPLICATION CHART).
NOTE: When cooking egg and milk products, the skillet should not be preheated, as products of this nature adhere to hot cooking surfaces. These types of foods should be placed in the skillet before heating is begun.
6. Place the food product into the skillet, distributing it evenly across the cooking surface. The indicator light will cycle on and off indicating the elements are cycling on and off. The cover should be off for most types of cooking or simmering. If cover is on, the vent cap can be used to reduce water content in product or allow steam to escape before lifting cover.
7. Pour the contents of the skillet into an appropriate container by tilting the skillet forward. Care should be taken to pour slowly enough to avoid splashing of the product.
8. Turn OFF the unit.

NOTE: As with cleaning food soil from any cookware, and important part of skillet cleaning is to prevent foods from drying on. For this reason, cleaning should be completed immediately after cooked foods are removed. Refer to the *Cleaning Instructions* for detailed skillet washing procedures.

TEMPERATURE APPLICATION CHART

Approximate Dial Temperature		
Application	°F	°C
Bain Marie	150-200	65-93
Slow Cooking	225	107
Braise	250-275	121-135
Saucepan, Low Griddle	325	163
Med, Griddle, Sauté, Steam	350	177
Fry, Shallow Oil	400-425	204-218

QUICK START GUIDE FOR EASYDIAL CONTROLS (SET-10)

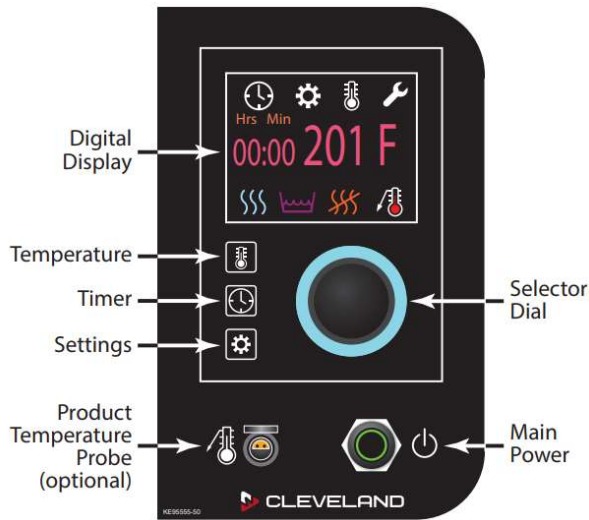

Settings include:

Units: Select: C or F degrees

Buzzer: Select: Cook/ON (cook & simmer)

Cook/Hold (cook & continuous cook)

Cook/OFF (cook & off)

Display: Select: Double (time & temperature)

Single (time or temperature)

Diagnostic: Select: NO or YES

Exit: Select YES to return to main screen

Indicator Lights

(Illuminated when power turned on)

1. Time
2. Settings
3. Temperature
4. Diagnostics
5. Heat ON
6. Low Water (kettles only)
7. Ignition Failure (gas models)
8. Product Temperature Probe

Diagnostic Functions (OK/Fail)

1. Safety: Monitors safety functions when unit is tilted.
2. Main Heater: Monitors main heating element safety contactor that remains ON all the time.
3. Second Heater: Monitors operating contactor that is responsible for cycling the unit.
4. Jacket Sensor: Monitors RTD (surface temp) sensor inside the jacket. Product Sensor: When Probe is connected.



To adjust settings:

Note: The last setting used becomes the default settings for when you power off and back on. To exit from **Settings** menu, toggle down to **Exit** select **Yes** and press **Settings** .

1. Push  to turn on Main Power. Wait four seconds.

2. Push **Settings**  to display the **Settings Screen**.

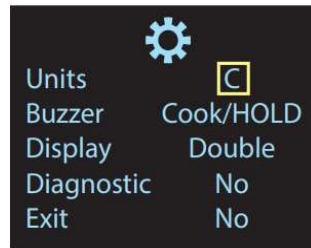

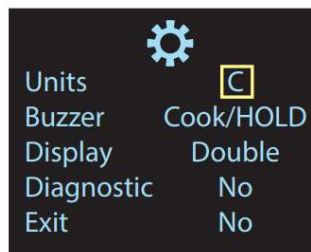

3. Settings the **Units**:

- Turn “**Selector Dial**”  to select degree Fahrenheit or Centigrade.



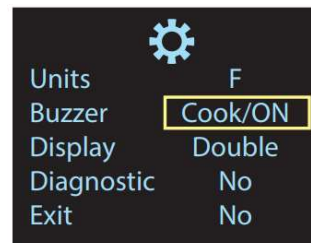

4. Setting the **Buzzer** (& Cooking Mode):

- Push **Settings**  to toggle to **Buzzer**.
- Turn “**Selector Dial**”  to select **Cook/ON** or **Cook/Hold** or **Cook/OFF**.



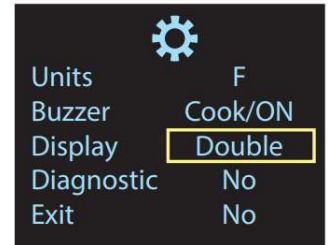

5. Setting the **Display**:

- Push **Settings**  to toggle to **Display**.
- Turn “**Selector Dial**”  to select **Double** or **single**.



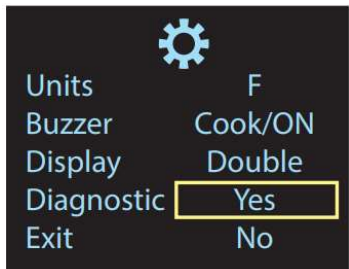

6. **Diagnostics**:

- Push “**Selector Dial**”  to toggle to **Diagnostics**.
- Turn “**Selector Dial**”  to select **No** or **Yes**.
- If **YES** selected, the diagnostic tests will begin when you exit the Setting Screen.



7. **Exiting the Settings**:

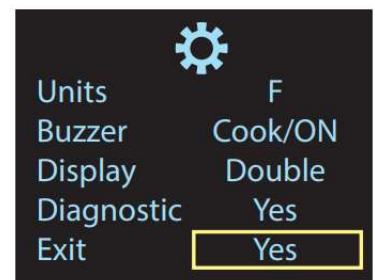

- Push **Settings**  to toggle to **Exit**.
- Turn “**Selector Dial**”  to select **Yes**.
- Push **Settings**  to **Exit**. These settings will now become the default settings for when your unit is turned off and on.







Cook/ON

For cooking by temperature only. The temperature will run continuously until manually turned off.

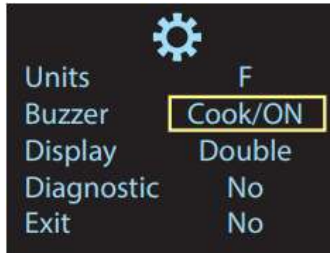
Setting the timer activates a buzzer (for adding spices, etc.).



1. Push  to turn on **Main Power**. Wait four seconds.
2. Adjust **Settings**  to Cook/ON. Exit settings.



3. Push **Temperature**  to select temperature.
 - Turn “**Selector Dial**”  to desired temperature.
 - Push **Temperature**  to enter setting. This will start the cooking cycle.





To set a buzzer for adding spices etc.(optional)

4. Push **Time**  to select **Hrs** and **Min**.
 - Turn “**Selector Dial**”  to set the buzzer to desired time.
 - Push **Time**  to start timing.





Cook/OFF

For cooking by time and temperature, the timer countdown turns off the heat. The heating cycle will start for a set time then shut down.

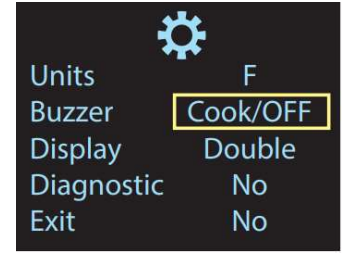

1. Push  to turn on **Main Power**. Wait four seconds.
2. Adjust **Settings**  to Cook/OFF. Exit settings.



3. Push **Temperature**  to select temperature.
 - Turn “**Selector Dial**”  to set desired temperature.
 - Push **Temperature**  to start cooking cycle.





To set a buzzer for adding spices etc.(optional)

4. Push **Time**  to select **Hrs** and **Min**.
 - Turn “**Selector Dial**”  to set the buzzer and turn off the cooking cycle.
 - Push **Time**  to start timing.



Cook/HOLD

For initial heating for a timed period then producing a hold temperature.

1. Push  to turn on **Main Power**. Wait four seconds.
2. Adjust **Settings**  to Cook/HOLD. Exit settings.

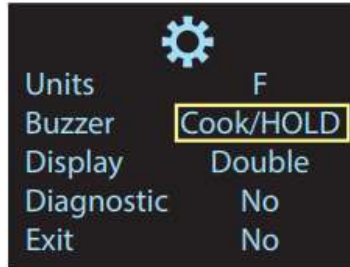



If a timer is not set, when the unit reaches the selected temperature, it will retain that temperature as shown in Chart #1.

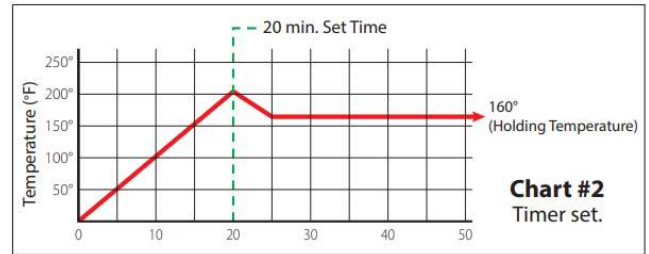

If the timer is set, when the set time has passed, the unit will drop to the holding temperature and retain that temperature as shown in Chart #2.





3. Push **Temperature**  to select temperature.
 - Turn “**Selector Dial**”  to set desired initial unit temperature.





Cooking with Product Probe

Heat can be controlled by a temperature probe placed in the product. When the product reaches a set temperature the unit jacket cycles off.



Can be used as an internal product probe or for simmering liquid products.

4. Push **Temperature**  to toggle to holding temperature setting.
 - Turn “**Selector Dial**”  to set desired holding temperature.
 - Push **Temperature**  to start cooking.





1. Connect probe to unit. Place probe sensor in product.
2. Push  to turn on **Main Power**. Wait four seconds.
3. Push **Temperature**  to select temperature.
 - Turn “**Selector Dial**”  to set desired temperature of unit (must be greater than temperature of probe).



5. Push **Time**  to select **Hrs** and **Min**.
 - Turn “**Selector Dial**”  to set the timer to desired time.
 - Push **Time**  to start timing.



4. Push **Temperature**  to enter setting and toggle to the product probe temperature setting.
 - Turn “**Selector Dial**”  to set desired product probe temperature. Push **Temperature**  to enter setting.



Probes Problem

This error message shows up when:

- a) Any of the temperature probes (Jacket and/or Product Probe) is damaged (short or open).
- b) The Product Probe is removed while EDC is controlling the system.
- c) The probe temperature is higher than the "Software Fuse Temperature (SFT)"
(Skillet's SFT is 550F; SSK's SFT is 288F).



If not TILTED, Heaters Problem

This error message shows up when the Safety is failing while the EDC is controlling the system.

In any case, run the Diagnostics.







CLEANING INSTRUCTIONS



CARE AND CLEANING

Cooking equipment must be cleaned regularly to maintain its fast, efficient cooking performance and to ensure its continued safe, reliable operation. The best time to clean is shortly after each use (allow unit to cool to a safe temperature).

WARNING

 <p>Chloride Cleaners</p>	<p>Do not use detergents or cleansers that are chloride based or contain quaternary salt.</p>
 <p>Wire Brush & Scrapers</p>	<p>Do not use a metal bristle brush or scraper.</p>
 <p>Steel Pads</p>	<p>Steel wool should never be used for cleaning the stainless steel.</p>
 <p>Stagnation Water</p>	<p>Do not leave water sitting in unit when not in use</p>
 <p>High Pressure Spray Hose</p>	<p>Unit should never be cleaned with a high-pressure spray hose.</p>

CLEANING INSTRUCTIONS

1. Turn the unit off.
2. Prepare warm water and mild detergent solution in the unit.
3. Remove food soil using a nylon brush.
4. Loosen food which is stuck by allowing it to soak at a low temperature setting.
5. Drain unit.
6. Rinse interior thoroughly.
7. Using mild soapy water and a damp sponge, wash the exterior, rinse, and dry.

NOTES

- For more difficult cleaning applications one of the following can be used: alcohol, baking soda, vinegar, or a solution of ammonia in water.
- Leave the cover off when the kettle is not in use.
- For more detailed instructions refer to Stainless Steel Equipment Care and Cleaning (www.nafem.org/resources/stainlesssteelfinal.doc) on Nafem's website (www.nafem.org).

DISPOSAL INSTRUCTIONS

This unit is recyclable. Do not dispose of it in landfill.

The unit may contain rust inhibitor and or antifreeze within the jacket. Drain unit and dispose following Federal, State, and local regulations.

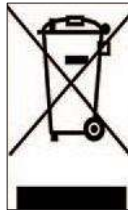

The majority of the unit is composed of stainless steel. Other alloys and electrical components make up a small percentage of the total. Follow Federal, state and local regulations for disposal.



PREVENTATIVE MAINTENANCE

FOR MAINTENANCE AND REPAIRS CONTACT YOUR AUTHORIZED MANITOWOC SERVICE AGENCY AND HAVE A QUALIFIED SERVICE TECHNICIAN MAINTAIN YOUR EQUIPMENT.



⚠ WARNING:

If for any reason this unit is not functioning correctly
DO NOT OPERATE.
Contact your authorized service agent.

Refer to maintenance procedures and parts list manual for detailed maintenance and testing instructions.



DAILY PRE-STARTUP INSPECTION

1. Tilt Handle is tight, and knob is in place.
2. EasyDial Digital Display is ON.

SIX MONTH SERVICE INSPECTION

1. Perform daily startup inspection.
2. Grease bearing on trunnion.
3. Fasteners securing panels are in place and tight.
4. Insure there are four screws firmly holding down the cover. If not replace screws and/or missing or worn nylon anchor nuts.
5. Unit is bolted in place.
6. Stand unit sits on is firmly anchored.

YEARLY SERVICE INSPECTION

1. Perform six-month service inspection.
2. Inspect safety thermostat for proper connections.

TROUBLESHOOTING AND MAINTENANCE PROCEDURES

The following trouble shooting guide and maintenance procedures are meant to be used by Qualified Service Technician.



DIAGNOSTIC GUIDE

This section contains service information intended for use by Authorized Service Personnel.

PROBLEM: Skillet has uneven heat over pan surface

Probable Cause

1. Defective contactor
2. Defective heating element block
3. Faulty wiring
4. Uneven torquing of aluminum heating blocks

Test and Remedy

Check contactor for burned out contacts and replace if required.

Check for continuity between element terminals and from terminals to ground. Either an open circuit between terminals or a short to ground indicates a faulty element. Replace if necessary.

Inspect the condition of wires and connections to elements and contactors. Repair if necessary.

Follow element block torquing procedure.

HEATING ELEMENT REMOVAL

1. Tilt the skillet forward to access bottom cover plate.
2. Make sure the power switch and external circuit breaker (at fuse box or breaker panel) are off.
3. Remove screws from bottom cover plate. Remove plate.
4. Remove all 7/16-inch nuts and washers from stainless retaining plate located at rear of skillet pan.
5. Remove screws and tooth lock washer from retaining bars and slide through open end where retaining plate was previously removed.
6. Disconnect electrical lead wires from elements.
7. Remove 5/16-inch nuts and spherical washers from heating element blocks. Care should be taken when removing nuts and washers to prevent breaking studs.
8. Remove heating elements blocks. Replace as needed.
NOTE: With new element block in place re-tighten nuts on spherical washers with a torque wrench to 11ft- lbs torque.
9. Replace retaining bars, retaining back plate and bottom cover.
10. Switch external power back on and return skillet to operating position. **WARNING:** Heating element blocks are very heavy. Use care when handling.

HEATING ELEMENT BLOCK TORQUING

Uneven torquing of heating element block retaining plate nuts may cause uneven heating of the cooking surface. To retorque, proceed as follows:

1. Tilt the skillet forward.
2. Ensure that the power switch and the external circuit breaker (at fuse box or breaker panel) are off.
3. Remove the bottom cover plate.
4. Loosen the 5/16 Inch nuts on the spherical washers.
5. Using a torque wrench, retighten the nuts to 11 ft-lbs torque.
6. Replace the bottom cover plate.

CALIBRATION INSTRUCTIONS

IMPORTANT: DO NOT ATTEMPT TO CALIBRATE THE THERMOSTAT

The electronic thermostat supplied with this skillet has been precisely calibrated at the factory and should not require field calibration.

Cleveland

Cleveland Range, LLC
760 Beta Drive, Unit D
Mayfield Village, Ohio
44143
216.481.4900
800.338.2204

Every new piece of Welbilt Foodservice equipment comes with KitchenCare® and you choose the level of service that meets your operational needs from one restaurant to multiple locations

StarCare – Warranty & lifetime service, certified OEM parts, global parts inventory, performance audited

ExtraCare — CareCode, 24/7 Support, online/mobile product information

LifeCare – Install & equipment orientation, planned maintenance, KitchenConnect™, MenuConnect®

Talk with KitchenCare® • 1-844-724-CARE • www.mtwkitchencare.com



To learn how Welbilt Foodservice and its leading brands can equip you, visit our global web site at www.welbilt.com, then discover the regional or local resources available to you.