



Visit www.clevelandrange.com to locate a service or sales representative in your area.



Electric Table Top Kettles

Installation, Operation, Maintenance, Parts & Service

This manual is updated as new information and models are released. Visit our website for the latest manual.

MODELS:

- KET-3-T
- KET-6-T
- KET-12-T
- KET-20-T
- TKET-3-T
- TKET-6-T
- TKET-12-T
- KET-6-TGB
- KET-12-TGB



For your future reference.

Model # _____

Serial # _____

← Model # & Serial #.



Read the manual thoroughly. Improper installation, operation or maintenance can cause property damage, injury or death.

TABLE OF CONTENTS

Statement of Responsibilities	1
For your Safety	2
Installation	4
Operating Instructions	7
Cleaning Instructions	8
Preventative Maintenance	9
Trouble Shooting & Maintenance	10
Reference Section	16
Service Parts	20



STATEMENT OF RESPONSIBILITIES / DÉCLARATION DES RESPONSABILITÉS / DECLARACIÓN DE RESPONSABILIDADES

This document is for use by experienced and trained Qualified Cleveland Range, LLC Authorized Service Representatives who are familiar with both the safety procedures, and equipment they service. Cleveland Range, LLC assumes no liability for any death, injury, equipment damage, or property damage resulting from use of, improper use of, or failure to use the information contained in this document. Cleveland Range, LLC has made every effort to provide accurate information in this document, but cannot guarantee that this document does not contain unintentional errors and omissions.

The information in this document may be subject to technical and technological changes, revisions, or updates. Cleveland Range, LLC assumes no liability or responsibility regarding errata, changes, revisions, or updates.

Qualified Cleveland Range, LLC Authorized Service Representatives are obligated to follow industry standard safety procedures, including, but not limited to, OSHA regulations, and disconnect / lock out / tag out procedures for all utilities including gas, electric, and steam powered equipment and / or appliances.

All utilities (gas, electric, water and steam) should be turned OFF to the equipment and locked out of operation according to OSHA approved practices during any servicing of Cleveland Range equipment

Qualified Cleveland Range, LLC Authorized Service Representatives are obligated to maintain up-to-date knowledge, skills, materials and equipment.

Ce document est destiné à l'usage des Représentants de Service qualifiés et autorisés de Cleveland Range, LLC qui possèdent l'expérience et la formation ainsi que la bonne connaissance des mesures de sécurité et du matériel qu'ils entretiennent.

Cleveland Range, LLC décline toute responsabilité pour tout cas de décès, blessure, dommage matériel ou dommage aux biens résultant de l'utilisation, de la mauvaise utilisation ou du manquement d'utilisation des renseignements contenus dans ce document.

Cleveland Range, LLC s'est efforcé à fournir des renseignements précis dans ce document mais ne peut garantir que ce document soit exempt d'erreurs et d'omissions non intentionnelles.

Les renseignements contenus dans ce document peuvent être assujettis à des changements techniques et technologiques, des révisions ou des mises à jour.

Cleveland Range, LLC décline toute obligation ou responsabilité concernant les errata, modifications, révisions ou mises à jour.

Les Représentants de Service qualifiés et autorisés de Cleveland Range, LLC sont tenus de se conformer aux mesures de sécurité normalisées de l'industrie, y compris, mais sans s'y limiter, les réglementations de l'OSHA, les procédures de débranchement / verrouillage / étiquetage relatives à tous les services publics, dont l'approvisionnement en vapeur, et les procédures de débranchement / verrouillage / étiquetage relatives aux équipements et/ou appareils fonctionnant au gaz, à l'électricité et à la vapeur.

Au cours de tout entretien d'un appareil Cleveland Range, tous les services publics (gaz, électricité, eau et vapeur) doivent être FERMÉS au niveau de l'appareil et le dispositif de fonctionnement doit être verrouillé suivant les pratiques approuvées de l'OSHA.

Les Représentants de Service qualifiés et autorisés de Cleveland Range, LLC sont tenus d'actualiser en permanence leurs connaissances, compétences, matériel et équipement.

Este documento está destinado para el uso de los Representantes de Servicio calificados y autorizados de Cleveland Range, LLC quienes cuentan con la experiencia y la capacitación así como el buen conocimiento de las medidas de seguridad y de los equipos que mantienen.

Cleveland Range, LLC, declina toda responsabilidad en caso de cualquier fallecimiento, lesiones, daños al equipo o daños a la propiedad resultantes de la utilización, del uso indebido o de la falta de utilización de la información provista en este documento.

Cleveland Range, LLC se ha esforzado en suministrar información precisa en este documento, pero no puede garantizar que este documento esté exento de errores y de omisiones no intencionales.

La información contenida en este documento podría estar sujeta a cambios técnicos o tecnológicos, revisiones o actualizaciones. Cleveland Range, LLC declina toda obligación o responsabilidad con respecto a erratas, modificaciones, revisiones o actualizaciones.

Los Representantes de Servicio calificados y autorizados de Cleveland Range, LLC tienen la obligación de seguir los procedimientos estándar de seguridad de la industria; los cuales incluyen pero no se limitan a los reglamentos de la OSHA (La Administración de la Seguridad y Salud Ocupacionales), los procedimientos de desconexión, cierre y etiquetado relativos a todos los servicios públicos incluyendo el suministro de vapor y los procedimientos de desconexión, cierre y etiquetado para los equipos y/o aparatos que funcionan a base de gas, electricidad o vapor.

Cuando se esté dando servicio o mantenimiento a un aparato de Cleveland Range, todos los servicios públicos (gas, electricidad, agua y vapor) deben estar APAGADOS para el equipo en cuestión y se debe seguir el procedimiento de cierre de operaciones de acuerdo con las prácticas aprobadas por la OSHA.

Los Representantes de Servicio calificados y autorizados de Cleveland Range, LLC tienen la obligación de actualizar constantemente sus conocimientos, destrezas, materiales y equipamiento.

FOR YOUR SAFETY / POUR VOTRE SÉCURITÉ / PARA SU SEGURIDAD

FOR YOUR SAFETY

Do not store or use gasoline or any other flammable liquids and vapours in the vicinity of this or any other appliance.

POUR VOTRE SÉCURITÉ

Ne pas entreposer ou utiliser d'essence ou d'autres liquides ou vapeurs inflammables à proximité de cet appareil ou de tout autre appareil.

PARA SU SEGURIDAD

No guarde ni use gasolina o cualesquiera otros líquidos o vapores inflamables en las cercanías de éste o cualquier otro aparato.

WARNING: Improper installation, operation, adjustment, alteration, service or maintenance can cause property damage, injury or death. Read the installation and operating instructions thoroughly before installing, operating or servicing this equipment.

AVERTISSEMENT : Toute mauvaise pratique en matière d'installation, de fonctionnement, de réglage, de modification, d'entretien ou de maintenance peut causer des dommages matériels, des blessures ou la mort. Lisez la totalité des instructions d'installation et d'utilisation avant d'installer, d'utiliser ou d'entretenir cet équipement.

ADVERTENCIA: La indebida instalación, operación, ajuste, modificación, servicio o mantenimiento puede ocasionar daños a la propiedad, lesiones o muerte. Lea detenidamente las instrucciones de instalación y de operación antes de instalar, poner a funcionar o dar servicio a este equipo.

Do not spray aerosols in the vicinity of this appliance while it is in operation.

This appliance is not to be used by persons with reduced physical, sensory or mental capabilities, or lack of experience and knowledge, unless they have been given supervision or instruction concerning use of the appliance by a person responsible for their safety.

This appliance is not for use by children and they must be supervised not to play with it.

Retain this manual for your reference.

Ne pas pulvériser des aérosols dans le voisinage de cet appareil alors qu'il est en fonctionnement.

Cet appareil ne doit pas être utilisé par des personnes dont les capacités physiques, sensorielles ou mentales sont réduites, ou des personnes dénuées d'expérience ou de connaissance, sauf si elles ont pu bénéficier, par l'intermédiaire d'une personne responsable de leur sécurité, d'une surveillance ou d'instructions préalables concernant l'utilisation de l'appareil.

Conservez ce manuel pour votre référence.

No pulverice aerosoles en las proximidades de este aparato mientras está en funcionamiento.

Este aparato no debe ser utilizado por personas con capacidades físicas, sensoriales o mentales reducidas, o que no tengan la experiencia y los conocimientos adecuados, a menos que estas personas hayan recibido supervisión e instrucciones en cuanto al uso del aparato por la persona responsable de la seguridad de ellas.

Guarde este manual para su referencia.



WARNING / AVERTISSEMENT / ADVERTENCIA



Improper installation, operation, adjustment, alteration, service or maintenance can cause property damage, injury or death. Read the installation and operating instructions thoroughly before installing, operating or servicing this equipment. / Toute mauvaise pratique en matière d'installation, de fonctionnement, de réglage, de

modification, d'entretien ou de maintenance peut causer des dommages matériels, des blessures ou la mort. Lisez la totalité des instructions d'installation et d'utilisation avant d'installer, d'utiliser ou d'entretenir cet équipement. / La indebida instalación, operación, ajuste, modificación, servicio o mantenimiento puede ocasionar daños a la propiedad, lesiones o muerte. Lea detenidamente las instrucciones de instalación y de operación antes de instalar, poner a funcionar o dar servicio a este equipo.



Do not lean on or place objects on lip. / Ne vous penchez pas sur ou ne placez pas des objets sur la lèvre. / No se apoye ni coloque objetos en el labio.



Hot product and surfaces. / Produit et surfaces chaudes. / Producto y superficies calientes.

Do not touch. / Ne pas toucher. / No la toque



Stand clear of product discharge path when discharging hot product. / Écartez-vous du chemin de décharge d'un produit chaud. / Permanezca alejado de la ruta de descarga del producto al vaciar producto caliente.



Keep hands away from moving parts and pinch points. / Gardez les mains loin des pièces mobiles et des points de pincement. / Mantenga las manos lejos de piezas móviles y puntos de presión muy localizada.



Inspect unit daily for proper operation. / Inspectez l'unité tous les jours pour son bon fonctionnement. / Inspeccione diariamente el funcionamiento correcto de la unidad.



Remove electrical power prior to servicing. / Coupez l'alimentation électrique avant l'entretien. / Desconecte la energía eléctrica antes de darle servicio.

Risk of electric shock. / Risque de choc électrique. / Riesgo de choque eléctrico.



Pressurized device. / Appareil sous pression. / Dispositivo de presión.

Keep clear of pressure relief discharge. / Restez à l'écart de la soupape de sûreté. / Permanezca alejado de la descarga de presión.



Surfaces and product may be hot! Wear protective equipment. / Les surfaces et le produit peuvent être chauds! Portez un équipement de protection. / ¡Las superficies y el producto pueden estar calientes! Utilice equipo protector.



Floor may become slippery from product spillage. / Déversement de produit peut causer de plancher à être glissant. / Derrame de producto puede causar piso a ser resbaladizo.



Unit must be anchored as per manual. / Unité doit être ancrée selon les directives du manuel. / Unidad debe estar fijado según el manual.



Do not fill kettle above recommended level marked on outside of kettle. / Ne remplissez pas la chaudière en excès du niveau recommandé marqué sur la chaudière. / No llene la marmita arriba del nivel recomendado marcado fuera de la marmita.



Heavy / Lourd / Pesado

Team or mechanical lift. / Équipe ou remontée mécanique. / Equipo o elevador mecánico.

SERVICING / ENTRETIEN / SERVICIO



Have a qualified service technician maintain your equipment. / Demandez à un technicien en entretien et en réparation qualifié d'effectuer l'entretien de votre équipement. / Haga que un técnico de servicio calificado mantenga su equipo



Ensure kettle is at room temperature and pressure gauge is showing zero or less prior to removing any fittings. / Assurez-vous que la chaudière est à température ambiante et que le manomètre est à zéro ou moins avant de retirer des accessoires. / Asegúrese de que la marmita esté a temperatura ambiente y el manómetro esté mostrando cero o menos antes de retirar cualquier accesorio.

INSTALLATION

GENERAL

Installation of the kettle must be accomplished by qualified electrical installation personnel working to all applicable local and national codes. Improper installation of product could cause injury or damage.

This equipment is built to comply with applicable standards for manufacturers. Included among those approval agencies are: UL, NSF, ASME/Ntl. Bd., CSA, CGA, ETL, and others. Many local codes exist, and it is the responsibility of the owner/installer to comply with these codes.

RECEIVING INSPECTION

Before unpacking visually inspect the unit for evidence of damage during shipping.

If damage is noticed, do not unpack the unit, follow Shipping Damage Instructions shown below.

SHIPPING DAMAGE INSTRUCTIONS

If shipping damage to the unit is discovered or suspected, observe the following guidelines in preparing a shipping damage claim.

1. Write down a description of the damage or the reason for suspecting damage as soon as it is discovered. This will help in filling out the claim forms later.
2. As soon as damage is discovered or suspected, notify the carrier that delivered the shipment.
3. Arrange for the carrier's representative to examine the damage.
4. Fill out all carrier claims forms and have the examining carrier sign and date each form.

APPROXIMATE WEIGHTS

Model #	Unit	Unit with shipping box
KET3T	95 lbs.	135 lbs.
KET6T/GB	160 lbs.	210 lbs.
KET12T/GB	180 lbs.	220 lbs.
KET20T	260 lbs.	300 lbs.
TKET3T	135 lbs.	175 lbs.
TKET6T	226 lbs.	266 lbs.
TKET12T	315 lbs.	355 lbs.



UNCRATING

Caution:

Straps under tension and will snap when cut.

Carton may contain staples and Skid contains Nails.

Use proper safety equipment and precautions.

Unit is heavy use adequate help or lifting equipment as needed.



1. Carefully cut any straps from container.
2. Lift off carton.
3. Inspect for hidden damage. If found refer to "SHIPPING DAMAGE INSTRUCTIONS".
4. Cut strap holding unit.

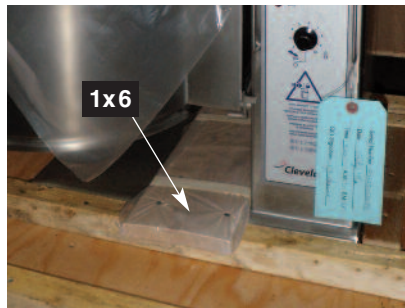

5. Remove 1X6 holding unit in place.
6. Remove manual from kettle pot. Write down the model # and serial# of the unit onto the front of this manual.
7. Lift kettle off skid and move kettle to its installation location.
8. Discard packaging material according to local and or state requirements.

VENTILATION

Operation of these units can produce significant levels of steam and condensate, it is recommended they be installed under a ventilation hood in a room which has provisions for adequate make up air. Further information can be obtained by referring to the U.S.A. National Fire Protection Associations NFPA96 regulations. These standards have also been adopted by the National Building Code in Canada.

POSITIONING

Units must be positioned on a firm, level stand that has been bolted in place, or existing counter top, and bolted in place.

For mounting, these models are supplied with four threaded bushings welded to the underside of the base.

The first installation step is to refer to the Specification Sheets or Specification Drawings for detailed clearance requirements and mounting hole locations of the kettle. If you don't have access to a specification sheet, check the bottom of the kettle for location of threaded mounting bushings.

CLEARANCE REQUIREMENTS

Model #	Back*	Left Side	Right Side
KET-3-T	0	0	0
KET-6-T	6"	0	0
KET-12-T	6"	0	0
KET-20-T	9"	0	0
TKET-3-T	7 1/8"	0	0
TKET-6-T	7 1/8"	0	0
TKET-12-T	9 7/8"	0	0

* From back of mounting base.

Countertop Models

1. Drill mounting holes. If mounting to a Cleveland stand holes are already predrilled.
2. Position the unit in its permanent location.
3. Once positioned permanently secure the unit to the mounting surface with the hardware provided.
4. Seal around base of unit with silicone sealant.
5. Remove protective material covering stainless steel surfaces.

KET-20-T Leg Type Models

For floor type leg mount models position on a firm, level surface, level using adjustable feet and bolt two flanged feet in place. Once the kettle is secure, screw tilt handle into the threaded hole provided at the right of kettle.

ELECTRICAL

ENSURE THE ELECTRICAL SUPPLY MATCHES THE KETTLE'S REQUIREMENTS AS STATED ON THE RATING LABEL.

Install in accordance with local codes and/or the National Electric Code ANSI/NFPA No. 70 (USA) or the Canadian Electric Code CSA Standard C22.2 (Canada). A separate fused disconnect switch must be supplied and installed. The kettle must be electrically grounded by the installer.

POUR PATHS

Kettle Size	Min.	Max.
3 Gallon	15 1/2"	32"
6 Gallon	17 1/4"	36"
12 Gallon	18"	38"
20 Gallon	22"	45"

A wiring diagram is affixed to the underside of the console cover.

Remove the four screws securing the console cover and remove the cover. Using a water tight fitting feed permanent copper wiring through the cut-out in the rear or bottom of the console, and fasten to the three connection terminal block, which is mounted on the top of the console's control panel. Be sure to connect the ground wire to the separate ground terminal connector (ground lug). Replace console cover and secure it with the four screws.

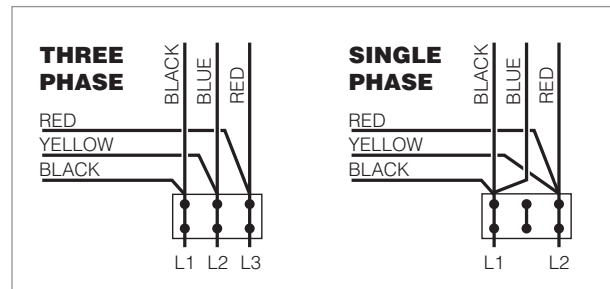

The kettle is wired for 3-phase operation at the factory. For single phase operation, rewire the terminal block to that shown in the above diagram.

Note: Ensure main power is turned off before connecting wires.

FAUCET SPOUT

The kettle can be equipped with optional hot and/or cold water faucet, requiring 1/2" copper tubing as supply lines. Mount faucet bracket to the rear of the unit or studs provided. Assemble faucet onto bracket and check for leaks.

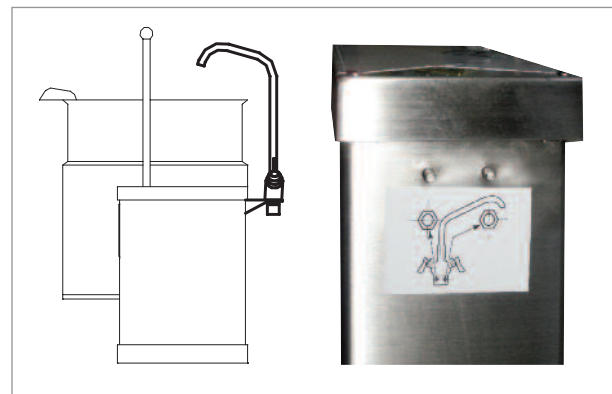

INSTALLATION CHECKS

Although the kettle has been thoroughly tested before leaving the factory, the installer is responsible for ensuring the proper operation of kettle once installed.



CLEANING

After installation the kettle must be thoroughly cleaned and sanitized prior to cooking. See Cleaning Instructions.

Visual Checks

1. Check unit is bolted in place.
1. Check Marine Lock. See Marine Lock Testing Procedure.
2. Check Tilting:
 - A/ Handle is in place and firmly tightened.
 - B/ Kettle tilts smoothly and freely.
3. Insure there are:
 - A/ Four screws securely holding the console cover.
 - B/ The bottom cover is in place and held with a nut.

Performance Checks

1. Supply power to the kettle by placing the fused disconnect switch to the "ON" position.
2. Before turning the kettle on, read the Vacuum/Pressure Gauge. The gauge's needle should be in the green zone. If the needle is in the "VENT AIR" zone, follow Kettle Venting Instructions.
3. Turn the kettle's ON/OFF Switch/Solid State Temperature Control to "1" (Min.). The Heat Indicator Light (Green) should remain lit, indicating the element is on, until the set temperature is reached (130°F/54°C). Then the green light will cycle on and off, indicating the element is cycling on and off to maintain temperature.
4. Tilt the kettle forward. After a few seconds the Low Water Indicator Light (Red) should be lit when the kettle is in a tilted position. This light indicates that the element has automatically been shut off by the kettle's safety circuit. This is a normal condition when the kettle is in a tilted position.
5. Raise the kettle to the upright position. The Low Water Indicator Light (Red) should go out when the kettle is upright.
6. Turn the ON/OFF Switch/Solid State Temperature Control to "10" (Max.) and allow the kettle to preheat. The green light should remain on until the set temperature (260°F/127°C) is reached. Then the green light will cycle ON and OFF, indicating the element is cycling ON and OFF to maintain temperature. Fill the kettle with cold water to the steam jacket's welded seam. Refer to the Temperature Range Chart for the time required to bring the water to a boil.
7. When all testing is complete, empty the kettle and turn the ON/OFF Switch/Solid State Temperature Control to the "OFF" position.



OPERATING INSTRUCTIONS



WARNING / AVERTISSEMENT / ADVERTENCIA

If for any reason this unit is not functioning correctly **DO NOT OPERATE.**
Contact your authorized service agent.

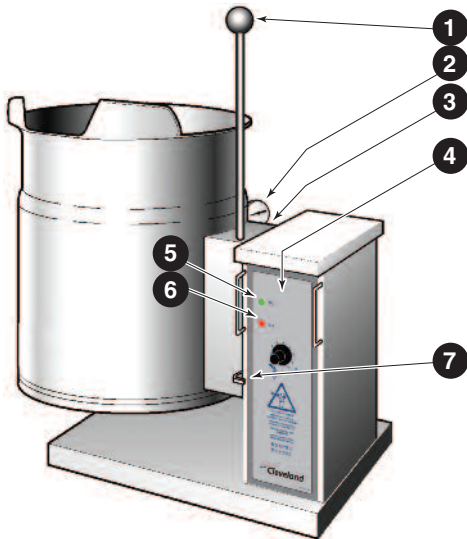

1. **Tilting Handle** - Used for tilting the kettle.
2. **Vacuum/Pressure Gauge** - Indicate steam pressure in PSI inside steam jacket as well as vacuum in inches of mercury.
3. **Pressure Relief Valve** (not shown) - This valve is used to vent the kettle and in the unlikely event there is an excess steam build-up in the jacket, this valve opens automatically to relieve this pressure.
4. **On-Off Switch/Solid State Temperature Control** - Turns kettle ON/OFF and allows the operator to adjust the kettle temperature in increments from 1 (Min.) to 10 (Max.). (see Temperature Range Chart in the Operating Instructions section).
5. **Heat Indicator Light** (Green) - When lit, indicates that the kettle element is on. Cycles ON-OFF with element.
6. **Low Water Indicator Light** (Red) - When lit, indicates that the kettle is low on water and will not operate in this condition. This will also light when the kettle is tilted.
7. **Marine Lock** - Prevents unit from accidental tilting.
8. **Hand Crank Option** - Replaces standard tilt handle.



Temperature Control Setting	Approximate Product Temperature	
	°F	°C
1. (Min.)	130	54
2.	145	63
3.	160	71
4.	170	77
5.	185	85
6.	195	91
7.	210	99
8.	230	110
9.	245	118
10. (Max.)	260	127

NOTE: Certain combinations of ingredients will result in temperature variations

Temperature Range Chart

APPROXIMATE BOILING TIMES

Kettle Capacity	Minutes
3 gallon/11 litre	15
6 gallon/23 litre	20
12 gallon/45 litre	25
20 gallon/80 litre	40

Approximate Boiling Times

The accompanying chart shows approximate times required for electric kettles of various capacities to boil water. The ON/OFF Switch/Solid State Temperature Control must be set at "10" (Max.) throughout the heatup period. Water will boil about 1/3 faster if the kettle is filled only to the outer steam jacket's welded seam, resulting in a kettle filled to 2/3 capacity.

MARINE LOCK -

(Tilt handle units)



Your unit is equipped with a marine lock to prevent accidental tilting. The following procedure should be used to tilt the kettle.

1. Grasp the tilt handle.
2. Hold the latch down to unlock tilting mechanism.
3. Pull the handle to tilt kettle.
4. To lock, return the kettle to its upright position and push handle back.

NOTE: Inspect lock daily to ensure it is free moving and does not bind or stick. Clean lock if necessary (see Cleaning Instructions for details)

Quick Start Guide for EasyDial controls

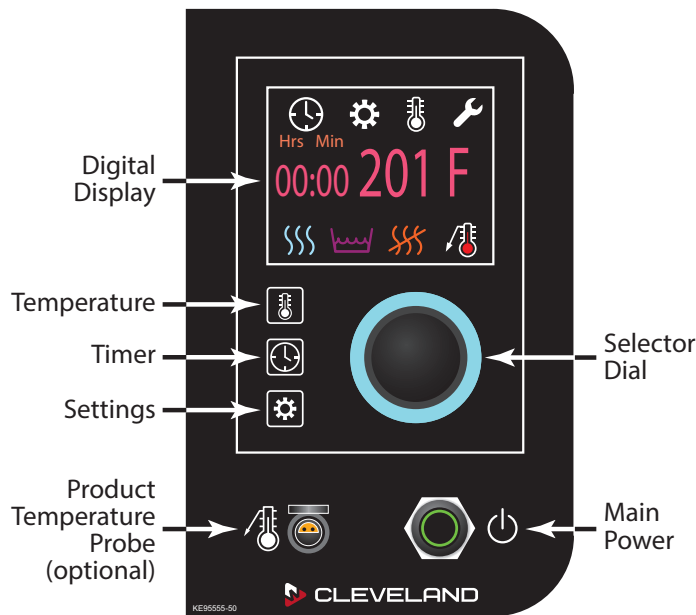

Settings include:

Units: Select: C or F degrees

Buzzer: Select: Cook/ON (cook & simmer)
Cook/Hold (cook & continuous cook)
Cook/OFF (cook & off)

Display: select: Double (time & temperature)
Single (time or temperature)

Diagnostic: Select: NO or YES

Exit: Select YES to return to main screen



Indicator Lights

(Illuminated when power turned on)

1. Time
2. Settings
3. Temperature
4. Diagnostics
5. Heat ON
6. Low Water (kettles only)
7. Ignition Failure (gas models)
8. Product Temperature Probe

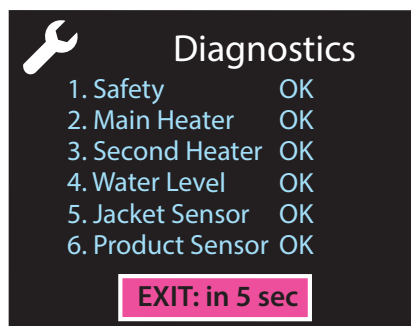

Diagnostic Functions (OK/Fail)

1. Safety: Monitors safety functions when unit is tilted.
2. Main Heater: Monitors main heating element safety contactor that remains ON all the time.
3. Second Heater: Monitors operating contactor that responsible for cycling the unit.
4. Water Level: Monitors water level in steam jacket.
5. Jacket Sensor: Monitors RTD (surface temp) sensor inside the jacket.
6. Product Sensor: When Probe is connected.

To adjust settings:

Note: The last setting used becomes the default settings for when you power off and back on. To exit from **Settings** menu, toggle down to **Exit** select **Yes** and press **Settings** .

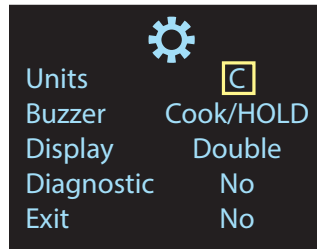

1. Push  to turn on **Main Power**. Wait four seconds.

2. Push **Settings**  to display the **Settings Screen**.



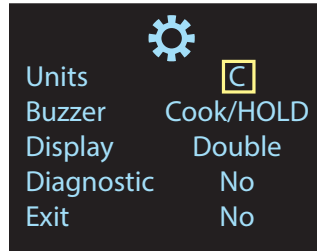

3. Setting the **Units**:
Turn **Selector Dial**  to select degrees Fahrenheit or Centigrade.

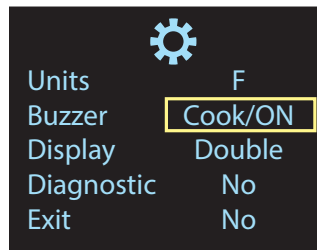

4. Setting the **Buzzer** (& Cooking Mode):
Push **Settings**  to toggle to **Buzzer**.
Turn “**Selector Dial**”  to select **Cook/ON** or **Cook/Hold** or **Cook/OFF**.



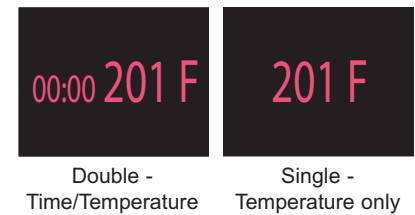
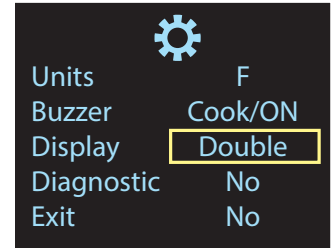

5. Setting the **Display**:
Push **Settings**  to toggle to **Display**.
Turn “**Selector Dial**”  to select **Double** or **Single**.



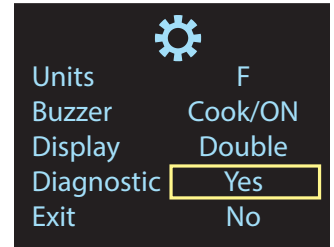

6. **Diagnostics**:
Push **Selector Dial**  to toggle to **Diagnostics**.

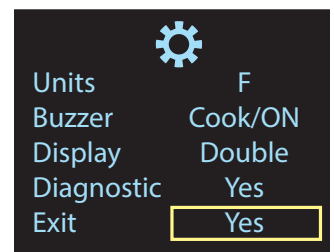

Turn “**Selector Dial**”  to select **No** or **Yes**.
If YES selected, the diagnostic tests will begin when you exit the Setting Screen.

7. **Exiting the Settings**:
Push **Settings**  to toggle to **Exit**.
Turn “**Selector Dial**”  to select **Yes**.



Push **Settings**  to **Exit**. These settings will now become the default settings for when your unit is turned off and on.

Cook/ON

For cooking by temperature only. The temperature will run continuously until manually turned off.

Setting the timer activates a buzzer (for adding spices, etc.).

1. Push  to turn on **Main Power**. Wait four seconds.

2. Adjust **Settings**  to Cook/ON. Exit settings.

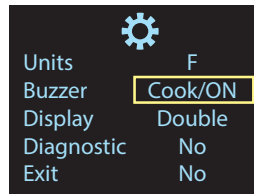

3. Push **Temperature**  to select temperature.

4. Turn **Selector Dial**  to desired temperature.

5. Push **Temperature**  to enter setting. This will start the cooking cycle.



To set a buzzer for adding spices etc. (optional)

6. Push **Time**  to select **Hrs** and **Min**.

7. Turn **Selector Dial**  to set the buzzer to desired time.

8. Push **Time**  to start timing.

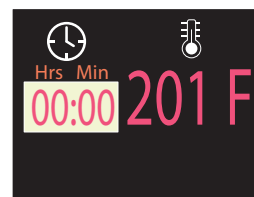



Cook/OFF

For cooking by time and temperature, the timer countdown turns off the heat. The heating cycle will start for a set time then shut down.

1. Push  to turn on **Main Power**. Wait four seconds.

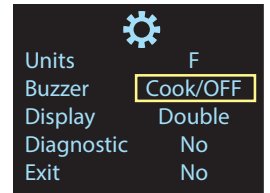
2. Adjust **Settings**  to Cook/OFF. Exit settings.



3. Push **Temperature**  to select temperature.

4. Turn **Selector Dial**  to set desired temperature.

5. Push **Temperature**  to start cooking cycle.



6. Push **Time**  to select **Hrs** and **Min**.

7. Turn **Selector Dial**  to set the buzzer and turn off the cooking cycle.

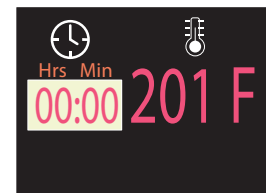

8. Push **Time**  to start timing.

Cook/HOLD

For initial heating for a timed period then producing a hold temperature.

1. Push to turn on **Main Power**. Wait four seconds.
2. Adjust **Settings** to Cook/HOLD. Exit settings.
3. Push **Temperature** to select temperature.
3. Turn **Selector Dial** to set desired initial unit temperature.
4. Push **Temperature** to toggle to holding temperature setting.
5. Turn **Selector Dial** to set desired holding temperature.
6. Push **Temperature** to start cooking.

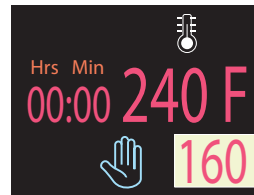
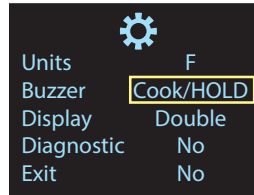

If a timer is not set, when the unit reaches the selected temperature, it will retain that temperature as shown in Chart #1.

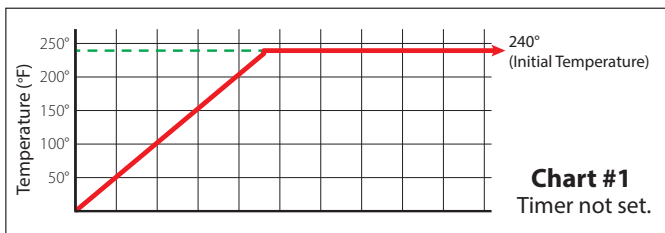

If the timer is set, when the set time has passed, the unit will drop to the holding temperature and retain that temperature as shown in Chart #2.

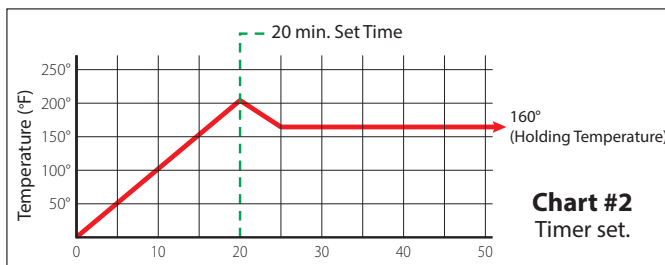

7. Push **Time** to select **Hrs** and **Min**.
8. Turn **Selector Dial** to set the timer to desired time.
9. Push **Time** to start timing.

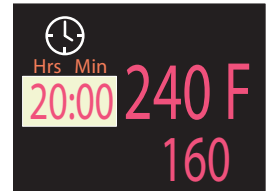

Cooking with product probe.

Heat can be controlled by a temperature probe placed in the product. When the product reaches a set temperature the unit jacket cycles off.

Can be used as an internal product probe or for simmering liquid products

1. Connect probe to unit. Place probe sensor in product.
2. Push to turn on **Main Power**. Wait four seconds.
3. Push **Temperature** to select temperature.
4. Turn **Selector Dial** to set desired temperature of unit (must be greater than temperature of probe).
5. Push **Temperature** to enter setting and toggle to the product probe temperature setting.
6. Turn **Selector Dial** to set desired product probe temperature.
7. Push **Temperature** to enter setting.

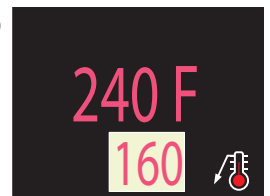
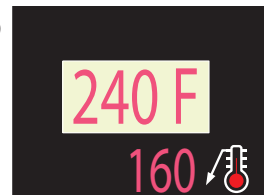

CLEANING INSTRUCTIONS



CARE AND CLEANING

Cooking equipment must be cleaned regularly to maintain its fast, efficient cooking performance and to ensure its continued safe, reliable operation. The best time to clean is shortly after each use (allow unit to cool to a safe temperature).

WARNINGS



Do not use detergents or cleansers that are chloride based or contain quaternary salt.

Chloride Cleaners



Do not use a metal bristle brush or scraper.

Wire Brush & Scrapers



Steel wool should never be used for cleaning the stainless steel.

Steel Pads



Unit should never be cleaned with a high pressure spray hose.

High Pressure Spray Hose



Do not leave water sitting in unit when not in use.

Stagnant Water

CLEANING INSTRUCTIONS

1. Turn unit off.
2. Remove drain screen (if applicable). Thoroughly wash and rinse the screen either in a sink or a dishwasher.
3. Prepare a warm water and mild detergent solution in the unit.
4. Remove food soil using a nylon brush.
5. Loosen food which is stuck by allowing it to soak at a low temperature setting.
6. Drain unit.
7. Rinse interior thoroughly.
8. Using mild soapy water and a damp sponge, wash the exterior, rinse, and dry.

NOTES

- ⇒ For more difficult cleaning applications one of the following can be used: alcohol, baking soda, vinegar, or a solution of ammonia in water.
- ⇒ Leave the cover off when the kettle is not in use.
- ⇒ For more detailed instructions refer to Stainless Steel Equipment Care and Cleaning (www.nafem.org/resources/stainlesssteelfinal.doc) on Nafem's website (www.nafem.org).

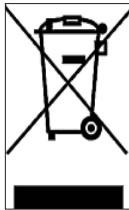

DISPOSAL INSTRUCTIONS

This unit is recyclable. Do not dispose in landfill.

The unit may contain rust inhibitor and or antifreeze within the jacket. Drain unit and dispose following Federal, State and local regulations.

The majority of the unit is composed of stainless steel. Other alloys and electrical components make up a small percentage of the total. Follow Federal, state and local regulations for disposal.



PREVENTATIVE MAINTENANCE

FOR MAINTENANCE AND REPAIRS CONTACT YOUR AUTHORIZED MANITOWOC SERVICE AGENCY AND HAVE A QUALIFIED SERVICE TECHNICIAN MAINTAIN YOUR EQUIPMENT.



WARNING / AVERTISSEMENT / ADVERTENCIA

If for any reason this unit is not functioning correctly
DO NOT OPERATE.

Contact your authorized service agent.

Refer to maintenance procedures and parts list manual
for detailed maintenance and testing instructions.



DAILY PRE-STARTUP INSPECTION

1. Tilt Handle is tight and knob is in place.
2. Kettle Tilt Lock is functioning correctly.
3. Pressure Gauge is in the green when unit is cold.
4. Green Light comes on when unit is energized.
5. Red Light comes on when unit is tilted.

SIX MONTH SERVICE INSPECTION

1. Perform daily startup inspection.
2. Grease bearings on both trunnions.
3. Inspect worm and gear assembly for proper engagement and that all screws and nuts are tight and in place. (hand crank only)
4. Fasteners securing panels are in place and tight.
5. Perform pressure relief valve periodic test (see Pressure Relief Valve Testing).
6. Insure there are four screws firmly holding down the cover. If not replace screws and/or missing or worn nylon anchor nuts.
7. Check the bottom cover gasket is in place and not cracked.
8. Unit is bolted in place.

YEARLY SERVICE INSPECTION

1. Perform six month service inspection.
2. Check kettle maximum temperature setting (see Calibrating Procedure).
3. Perform safety inspection using SAFETY INSPECTION CHECKLIST found in the MAINTENANCE PROCEDURES.

TROUBLESHOOTING AND MAINTENANCE PROCEDURES

The following trouble shooting guide and maintenance procedures are meant to be used by Qualified Service Technician



ANY REPAIRS TO THE PRESSURE VESSEL MUST BE DONE BY A CERTIFIED PRESSURE VESSEL REPAIR SHOP AND ALL REPAIR METHODS AND MATERIALS MUST BE APPROVED BY THE MANUFACTURER.

For periodic maintenance recommendations see “Operators Manual”.

Extreme caution must be taken if unit is electrically energized for testing.

Remove power from the unit while servicing.

DIAGNOSTIC GUIDE

This section contains servicing information intended for use by Authorized Service Personnel.

NOTE 1: If Fault Isolation Procedure is required, be sure to start at step #1.

NOTE 2: On table top kettles the entire control mounting panel may be removed from kettle control housing for easier troubleshooting and parts replacement.

A/ Problem: Kettle is not heating at all. (Kettle must be on and temperature control set.)

Possible Causes

- | | | |
|-----------------------------|---|---------------------------------------|
| 1. No incoming power. | 6. Defective safety thermostat. | 10. Defective thermistor. |
| 2. Kettle is tilted. | 7. Defective contactor/s. | 11. Defective 240/16 VAC transformer. |
| 3. Low water condition. | 8. Defective potentiometer (temperature control). | 12. Defective control box. |
| 4. Defective ON/OFF switch. | 9. Defective low water level probe. | 13. Defective elements. |
| 5. Defective 12 VDC relay. | | |

Fault Isolation Procedure

Step Test

1. Is there proper incoming voltage at terminal block?
Yes - Go to step #2.
No - Correct external power supply problem.
2. Is the red LED illuminated?
Yes - Follow Reservoir Fill Procedure. If this does not correct the problem, go to Problem D.
No - Go to step #3.
3. Is the green LED illuminated?
Yes - Go to step #4.
No - Go to step #7.
4. Do both contactors energize?
Yes - Check contactor contacts for pitting. Voltage across contactor terminals while in a closed position indicates a poor contact. Replace contactor/s as necessary. Check elements for short at ground or an open circuit. If element/s are defective contact the factory. Elements are not field replaceable.
No - Go to step #5.
5. Measure continuity across safety thermostat. Is it an open circuit?

- Yes - Replace defective safety thermostat.
No - Go to step #6.
6. Is there 120 VAC present across the coils of the contactors?
Yes - Replace defective contactor/s.
No - Go to step #7.
7. Remove wire from low water level probe and ground it to the body of the kettle. Do the contactors now energize?
Yes - Clean or replace defective low water level probe. Replace defective red LED.
No - Go to step #8.
8. Is there 16 VAC present at output of 16 VAC transformer?
Yes - Go to step #9.
No - Replace defective 240/16 VAC transformer.
9. Measure continuity of ON/OFF switch/ temperature control. Is it operating properly?
Yes - Go to step #10.
No - Replace defective ON/OFF switch/temperature control.
10. Unplug control box and measure the resistance across potentiometer. Is it approximately 0 ohms at maximum setting and 50,000 ohms at minimum?
Yes - Go to step #11.
No - Replace defective potentiometer (ON/OFF switch/temperature control)
11. Remove edge connector from control box. While kettle is cold or thermistor is removed and allowed to cool, measure the resistance between edge connector's pins #2 and #7. Is it approximately 100,000 ohms?
Yes - Spray contact cleaner on control box terminals and edge connector. Try box again, if the problem still exists, replace

B/ Problem: Kettle heats too slowly or not hot enough. (Note: normal max. operating pressure with an empty kettle is 30-35 psi.)

Possible Causes

- | | |
|---|---------------------------|
| 1. Air in jacket requires venting. | 5. Defective contactor/s. |
| 2. Defective safety thermostat. | 6. Defective control box. |
| 3. Defective potentiometer (temperature control). | 7. Defective element/s. |
| 4. Defective thermistor. | |

Fault Isolation Procedure

Step Test

1. In a cold state, does the pressure gauge read in the green zone?
Yes - Go to step #2.
No - There is air present in the jacket of the kettle. Follow Kettle Venting Procedure. If constant venting is required, there is a leak that should be corrected.
2. Do the contactors shut off too early? (before reaching normal maximum operating pressure.)
Yes - Go to step #3.
No - Check contactor contacts for pitting. Voltage across terminal of contactor while energized signifies a poor contact. Replace contactor/s as necessary. Check elements for short to ground or open circuit. If elements are defective, contact the factory. Elements are not field replaceable.
3. Does the green LED remain illuminated after the contactors shut off?
Yes - Replace defective safety thermostat.
No - Go to step #4.
4. Unplug control box and measure the resistance across potentiometer (temperature control). Is it approximately 0 ohms at maximum and 50,000 ohms at minimum setting?
Yes - Go to step #5.
No - Replace defective thermistor.
5. Remove kettle thermistor and allow to cool. Remove edge connector from control box. Test resistance across edge connector's pins #2 and #7. Is it approximately 100,000 ohms?
Yes - Go to step #6.
No - Replace defective thermistor
6. Turn the potentiometer on the control box clockwise to increase the maximum operating temperature. Does the kettle now achieve maximum operating pressure of 30-35 psi in an empty kettle?
Yes - Kettle is operating correctly.
No - Spray contact cleaner on control terminals and edge connector. Try box again. If problem still exists, replace defective control box.

C/ Problem: Kettle is overheating.

Possible Causes

1. Defective thermistor
2. Defective potentiometer (temperature control).
3. Defective 12 VDC relay.
4. Defective control box.

Fault Isolation Procedure

Step Test

1. Does the green LED turn off even though the contactors remain energized?
Yes - Replace defective 12 VDC relay.
No - Go to step #2.
2. Unplug the control box and measure the resistance across the potentiometer (temperature control), Is the resistance approximately 0 ohms at maximum and 50,000 ohms at minimum setting?
Yes - Go to step #3.
No - Replace defective thermistor.
3. Remove kettle thermistor and allow to cool Remove edge connector from control box. Test resistance across edge connector's pins #2 and #7. Is it approximately 100,000 ohms?
Yes - Go to step #4.
No - Replace defective thermistor.
4. Turn the potentiometer (temperature control) on the control box counter-clockwise to decrease the maximum operating temperature. Does the kettle continue to overheat?
Yes - Spray contact cleaner on control box terminal and edge connector. Try box again. If problem still exists, replace defective control box.
No - Kettle is operating correctly.

D/ Problem: Red LED remains illuminated even though water has been added.

Possible Causes

1. Defective low water level probe
2. Defective control box.

Fault Isolation Procedure

Step Test

1. Remove wire from low water level probe and ground the wire to the body of the kettle. Does the red LED turn off?
Yes - Replace or clean defective low water level probe.
No - Spray contact cleaner on control box terminals and edge connector. Try box again. If problem still exist, replace defective control box.

SAFETY INSPECTION CHECKLIST

NOTE: The following instructions are intended for use by qualified service personnel. The following steps should be completed **IN SEQUENCE**.



A/ KETTLE PREPARATION

1. Disconnect main power at fused disconnect switch.
2. Kettle should be cold. If necessary add water to kettle pot to cool unit.
3. The pressure gauge should now show a vacuum and have no indication of leakage. If gauge looks damaged replace gauge.
4. Gauge must be showing a vacuum prior to proceeding. If not check for leaks, and repair kettle prior to proceeding. Refer to REFERENCE SECTION (KETTLE VENTING INSTRUCTIONS).



Pressure Gauge in Vacuum.

B/ MECHANICAL CHECKS

1. Inspect controls, replace damaged seals, switches, LED's etc..
 2. Remove the console cover and check that the seal is not cracked or split. Replace seal, screws, missing or worn nylon anchor nuts. **Leave cover off.**
 3. Remove the kettle bottom cover and check that the seal is not cracked or split. **Leave cover off.**
- 4A. For units with tilt handle-**
- A. Check handle for tightness. If loose apply lock tight and reinstall. Check handle knob is on end of handle and firmly tightened. If missing replace, if loose apply lock tight and reinstall.
 - B. Check that kettle tilts smoothly and there is no excessive wear in the trunnion bearings. Add grease to nipples as required.
- 4B. For units with tilt crank-**
- A. Check that the kettle tilts smoothly. If there is excess play adjust the worm to gear clearance with Locking Nuts or Adjusting Screw as required.
 - B. Check that there is no excessive wear in the trunnion bearings.
 - C. Apply grease to gear teeth and bearings.

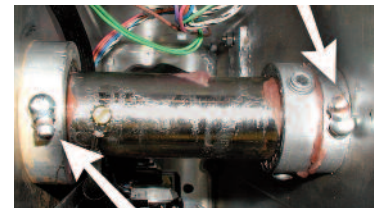

4A. Grease Nipples.

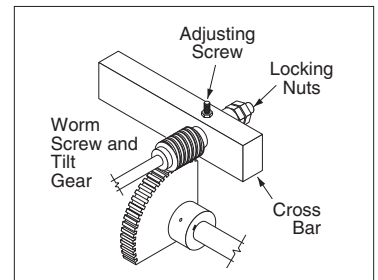

4B. Illustration inverted for clarity.

C/ MARINE LOCK TEST

1. Check that lock mechanism is not bent or damaged.
2. Check that lock clears stop pin on side box without rubbing when kettle is tilted (Figure A).
3. Check side to side play. Lock should remain fully over stop pin when pushed to it's maximum side to side play (Figure B).
4. Check that the kettle when pushed fully upright forces the lock to a closed position. To check this:
 - A/** Hold the latch firmly in the unlocked position while tilting the kettle back to an upright position.
 - B/** The kettle sidebox will force the lock into a new position.
 - C/** Hold the lock in this position and try to tilt the kettle forward. The latch should prevent the kettle from tilting.
5. Check shoulder bolt is firmly seated against console body.
6. Check on inside of console box that shoulder bolt locknut is secure.

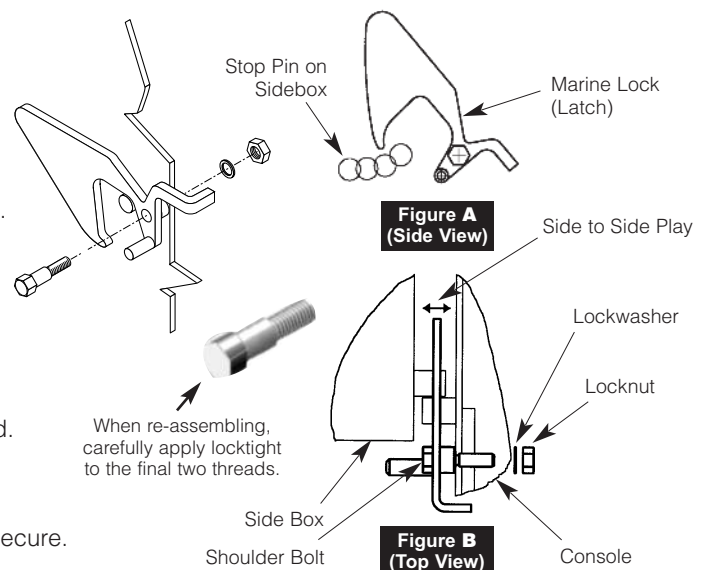

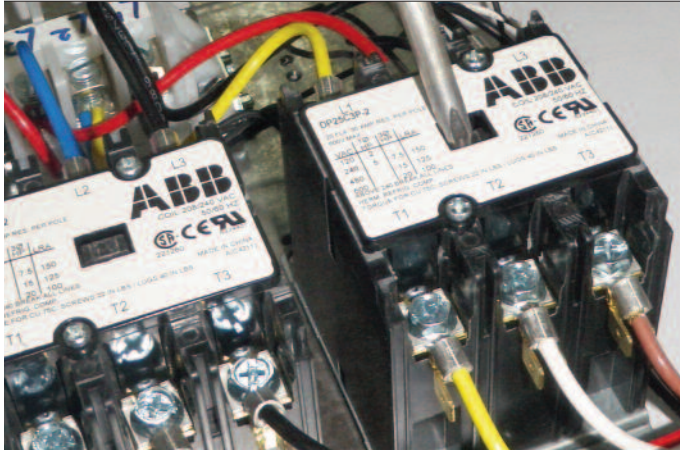

D/ CONTACTOR TEST

1. Remove power to unit.
2. Remove nut holding component mounting plate to console.
3. Pull plate out and place on top of console. (Depending on how the installer wired the kettle you may have to remove the supply wire and reconnect).
4. Physically push in on contacts of each contactor to check for free movement. Replace contactor(s) if required.

E/ LOW WATER LEVEL PROBE:

Installation Check:



✓ Probe properly attached

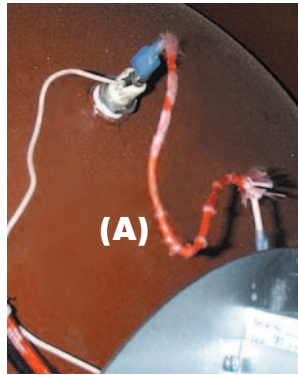

✗ Probe bypassed by running (A) an additional wire

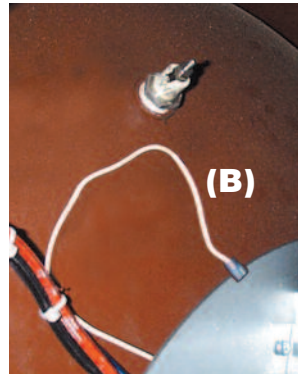

✗ Probe bypassed by (B) grounding the connecting wire

Functional Test:

1. Turn main power on at fused disconnect switch.
2. Turn kettle on and set temperature to maximum.
3. Green light will come on and contactors close.
4. Tilt kettle over. After approximately a five-second delay the red light will come on, green light goes off and the contactors will disengage.
5. Turn kettle upright. Green light will come back on and contactors reengage.
6. Turn kettle off
7. If unit does not function as above, make required repairs.
8. Disconnect main power at fused disconnect switch.

F/ SAFETY THERMOSTAT

Installation Check:

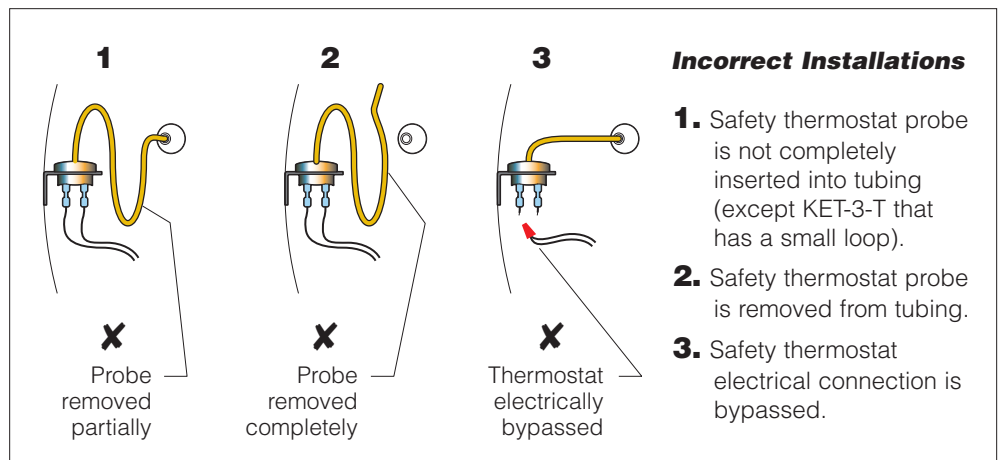
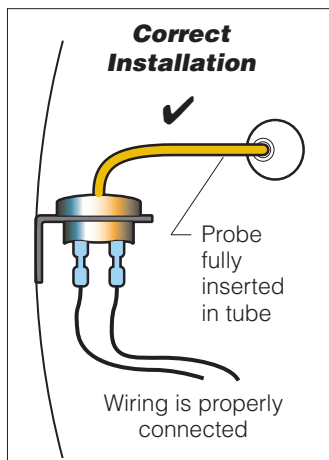

G/ SAFETY VALVE



Installation Check:

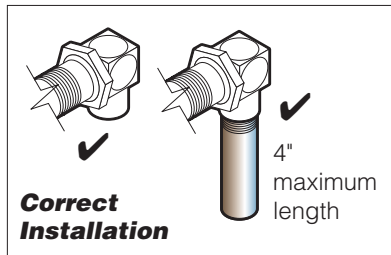

The above illustrations show the variations of factory installed Safety Valves. **Any modifications are unacceptable.**

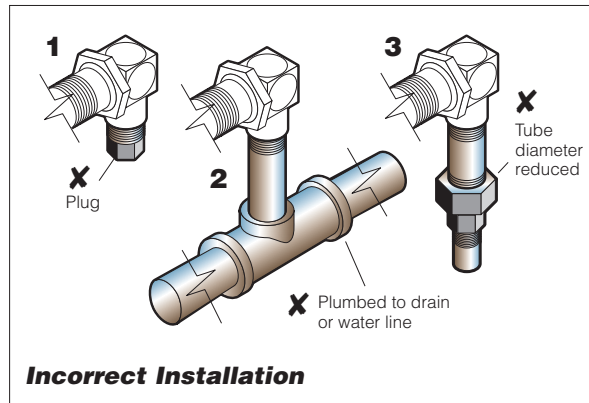

Physical Checks

1. Check that the PSI rating on the valve matches MAWP (maximum allowable working pressure) on the plate welded to the kettle.
2. Check that the Safety Valve has a "UV" stamp.
3. Check that the valve is not damaged in any way.

If any of the above criteria is not met, replace valve.

Pressure Relief Valve Periodic Testing Procedure

1. With the kettle empty, set On-Off Switch/Temperature Control to "10" (Max.). Allow the kettle to heat until the unit cycles off.
2. Switch On-Off Switch/Temperature Control to "0" (Off) and disconnect main power at fused disconnect switch.
3. Stand to the side of the pressure relief valve discharge tube and pull valve open for a maximum of one second. Repeat test three to four times. Each time the mechanism should move freely and be accompanied by a rapid escape of steam.

If valve appears to be sticking replace pressure relief valve.

If foreign material is discharged then drain kettle and replace pressure relief valve.

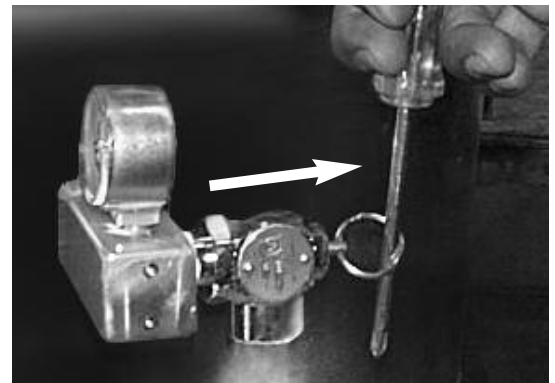

H/ CALIBRATING PROCEDURE

1. Kettle must be empty when this procedure is executed.
2. Insure the unit has a vacuum before you begin calibrating procedures. If unit requires venting see REFERENCE SECTION (KETTLE VENTING INSTRUCTIONS).
3. Turn kettle ON and set temperature dial to 10 (Max.).
4. Allow the unit to cycle twice (the green light must go on and off).
5. Check temperature of the inner kettle surface with a digital surface thermometer. For accurate readings move probe around bottom of kettle to locate the hottest location.
6. Temperature should be between 260° F and 265° F. Pressure gauge should read between 20 - 28 PSI.
7. Using a screw driver adjust temperature by turning the potentiometer on the black box. Turn very little. Turn clockwise to INCREASES and counter-clockwise to DECREASE temperature.
8. Allow the unit to cycle twice.
9. Re-check temperature.
10. Repeat steps 7 - 9 until unit is calibrated.

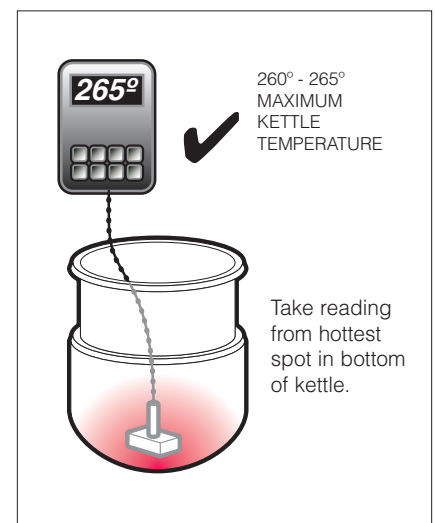

REFERENCE SECTION

RESERVOIR FILL PROCEDURES

The kettle's water level must be maintained at the proper level to submerge the heater elements. Under normal operating conditions, the sealed water reservoir should never require the addition of water.

If the red "low water" light comes on during use (while the kettle is in an upright position), the water level has reached a critically low level. The low water protection control has automatically shut off the heater elements. The following procedure must be completed before further use:

NOTE: Have a qualified service technician repair the leakage problem and add water to the unit. Ensure that the red "low water" light is on when the kettle is upright. On tilting kettles, it is normal for the red light to come on when the kettle is in a tilted position, as the elements are not submerged in water at this point.

CAUTION: Only a mixture of distilled water and rust inhibitor should be used when adding water to a partially filled water reservoir. Local tap water conditions may cause kettle damage which is not covered under warranty. Rust inhibitor is purchased locally. Read directions and do not exceed manufacturer's recommendation (excessive rust inhibitor can also cause solidification).

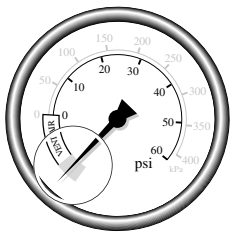

1. Ensure kettle is at room temperature and pressure gauge showing zero or less pressure.
2. Shut off power to the kettle at the fused disconnect switch.

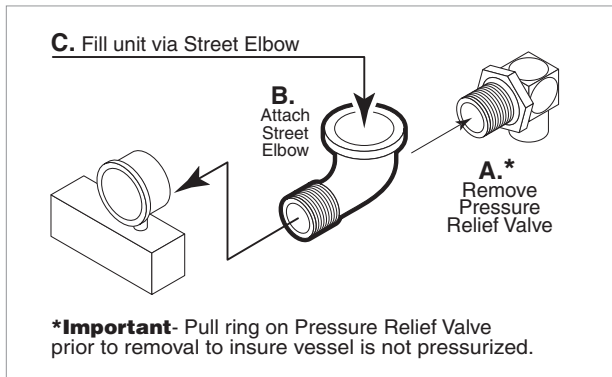

3. Pull Pressure Relief Valve (A) open to insure vessel is not pressurized.
4. Remove Pressure Relief Valve (A).
5. Replace Pressure Relief Valve (A) with Street Elbow (B).
6. Add Spring Water (C) through the Street Elbow (B), using a funnel if necessary. Refer to SPRING WATER REQUIREMENTS chart for the proper amount required.
7. Apply a thread sealant (i.e. Teflon tape) to the Pressure Relief Valve's (A) thread and replace.
8. Restore power to unit at the fused disconnect switch.
9. The kettle must now be vented. (Refer to the KETTLE VENTING INSTRUCTIONS).

SPRING WATER REQUIREMENTS

Kettle Capacity	When Red "Low Water Light" comes on, add Distilled Water	When the Reservoir is Completely Empty, Add Distilled Water
3 gallon	50 ounces	120 ounces
6 gallon	70 ounces	160 ounces
12 gallon	120 ounces	2 gallon
20 gallon	1 gallon	3 gallon
25 gallon	1.0 gallon	3.8 gallon
30 gallon	1.5 gallon	4.3 gallon
40 gallon	2.0 gallon	4.8 gallon
60 gallon	2.1 gallon	5.8 gallon
80 gallon	2.6 gallon	6.5 gallon
100 gallon	2.8 gallon	7.3 gallon

DRAINING PROCEDURE



WARNING: THE FUSED DISCONNECT SWITCH MUST BE OFF BEFORE REMOVING THE KETTLES BOTTOM COVER.

Draining procedure

1. Pull pressure relief valve to insure there is no pressure within the kettle jacket.
2. Remove bottom covers.
3. Remove low water level probe and allow water to drain.
4. To rinse kettle jacket:
 - a) On tilting kettles fill jacket from low water probe fitting.
 - b) On stationary kettles:
 1. Replace low water probe.
 2. Remove pressure relief valve and replace with street elbow.
 3. Using a small funnel (one made of paper works great) slowly pour water into the kettle.
5. Allow kettle to drain again.
6. Repeat until water drains clear.

REFILLING UNIT

1. Apply a thread sealant (i.e. Teflon tape) to the water level probe threads and replace.
2. See RESERVOIR FILL PROCEDURE

REPAIRING LEAKS IN STEAM JACKETED KETTLE FITTINGS

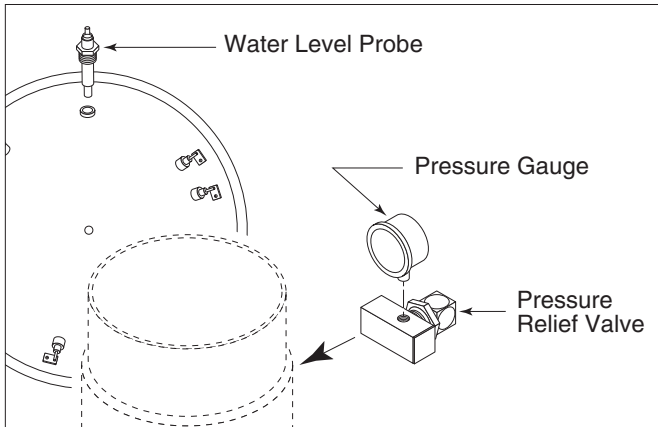

If unit will not hold a vacuum the most likely cause is a leak at one of the fittings. Often, the easiest way to eliminate a leak is reseal the suspect areas.

1. Water Level Probe Remove, clean threads, apply teflon thread sealant and reinstall.
2. Pressure Relief Valve **A/** Inspect for signs of leaks. Replace if required.
 B/ Remove, clean threads, apply teflon thread sealant and reinstall.
3. Pressure Gauge **A/** Inspect face of gauge. If it contains moisture on the inside of face replace.
 B/ Remove, clean threads, apply teflon thread sealant and reinstall.

THERMISTOR REPLACEMENT

1. Disconnect main power at fused disconnect switch.
2. Remove bottom cover.

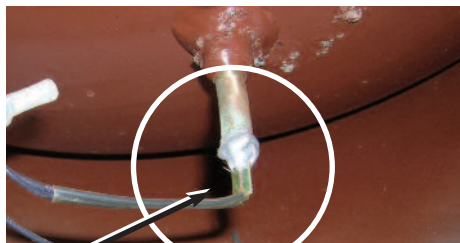

3. Locate thermistor.



4. Cut pigtail connection off.

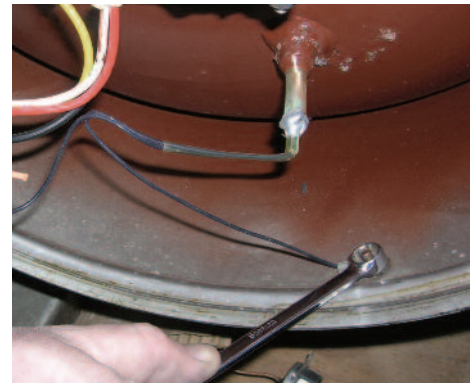

5. Remove wire from ground lug.
6. Remove thermistor from tube.



7. Add new "eye" connector to one of the thermistor leads and fasten to ground lug.

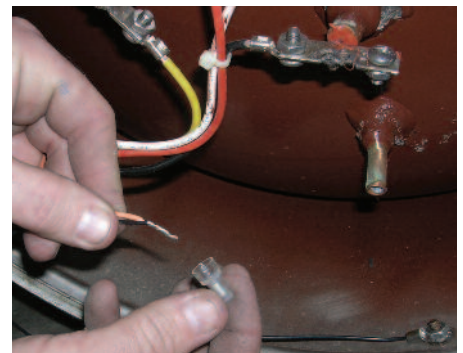

8. Connect orange wire to the other thermistor lead and fasten with pigtail connector.



9. Insert thermistor as far as possible into tube and hold in place. While holding add silicon to secure thermistor into tube. Insure silicon completely surrounds tube and thermistor.
10. Replace covers, reconnect power and test operation.

KETTLE JACKET CLEANOUT AND PASSIVATION PROCEDURES

The following procedure should be performed at least once every three years to prevent possible corrosion and ensure the optimum life of the kettle.



DANGER:



Rust inhibitor can be dangerous. Read label and follow safety instructions.

WARNING:



Improper refilling of kettle jacket will result in irreversible damage to unit.

RUST INHIBITOR

Use a "radiator rust inhibitor" that can be purchased at your local automotive centre. It should not contain any anti-freeze and preferably no lubricant.

To ensure satisfactory mixing follow the manufacturer's instructions.

DISPOSAL - Follow all Federal, State and local codes when disposing of product.

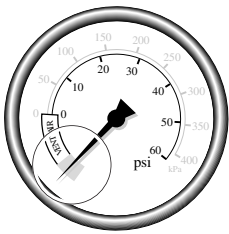

1. Ensure kettle is at room temperature and pressure gauge showing zero or less pressure.
2. Shut off power to the kettle at the fused disconnect switch.

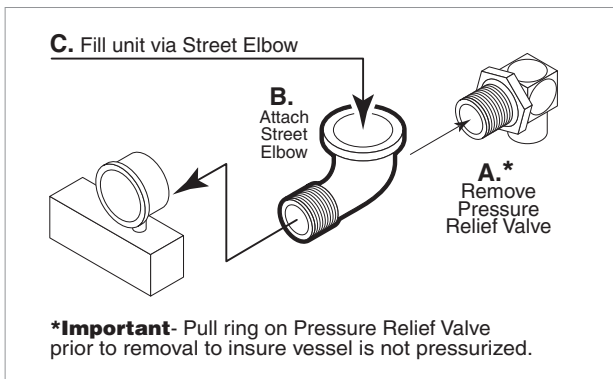

3. Pull Pressure Relief Valve (A) open to insure vessel is not pressurized.
4. Remove Pressure Relief Valve (A).
5. Replace Pressure Relief Valve (A) with Street Elbow (B).
6. Add Spring Water (C) through the Street Elbow (B), using a funnel if necessary. Refer to SPRING WATER REQUIREMENTS chart for the proper amount required.
7. Apply a thread sealant (i.e. Teflon tape) to the Pressure Relief Valve's (A) thread and replace.
8. Restore power to unit at the fused disconnect switch.
9. The kettle must now be vented. (Refer to the KETTLE VENTING INSTRUCTIONS).

KETTLE VENTING INSTRUCTIONS

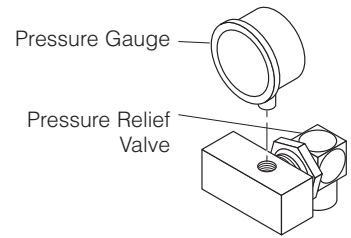
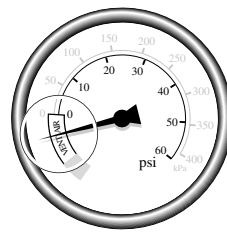

The following venting procedure should be followed when the Vacuum/Pressure Gauge needle is in the "VENT AIR" zone:

NOTE: Check for and eliminate leaks prior to venting (See REPAIRING LEAKS IN STEAM JACKETED KETTLE FITTINGS).

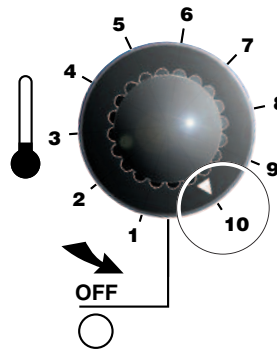

1. Set On-Off Switch/Temperature Control to "10" (Max.). Heat the empty kettle until unit cycles off.

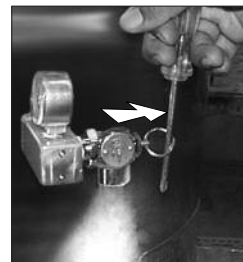

2. Vent kettle by pulling safety valve ring 8-10 times in short 2-3 second blasts with a 5 second interval between pulls.

NOTE: If unit cycles ON, stop venting and wait for kettle to cycle OFF before continuing.

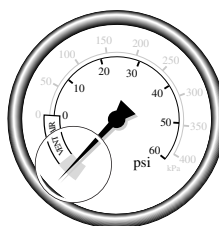

3. Turn kettle OFF. Add cold water to kettle until its surface temperature is below 100°F. The pressure gauge needle should be in the green zone, indicating a vacuum in the kettle's jacket.

LUBRICATION PROCEDURE

Lubricate the following parts every three months to insure smooth operation and reduce wear.

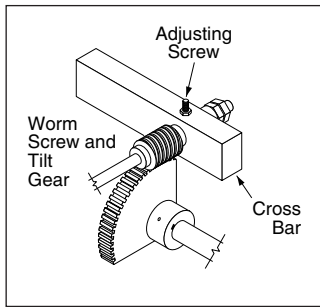

TRUNNION HOUSING, WORM SCREW AND TILT GEAR

These parts are accessed through the top cover of the console.

Apply grease to gear teeth. Check for excessive play and adjust with adjusting screw located on top of cross bar.

KETTLE TRUNNIONS

On the left hand side of the kettle there are two grease nipples on the top back portion of the trunnion housing. On the right hand side of the kettle you must remove the console cover to access the two grease nipples.

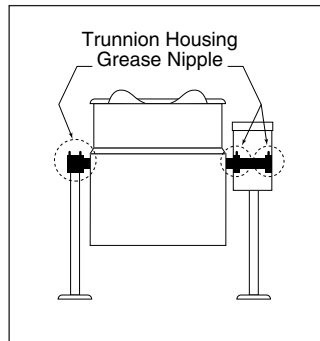

HINGE ADJUSTMENT INSTRUCTIONS

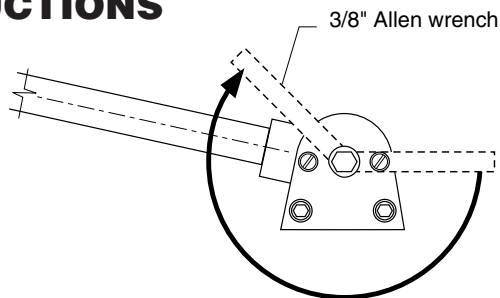

1. Insert 3/8" Allen wrench.
2. Turn clockwise to relieve tension on spring.
3. While tension is released remove one of the two slotted screws.
4. To prevent Allen wrench from springing back abruptly while the second slotted screw is removed, insert a pin (approximately 1/8") in the hole where the first slotted screw was removed from.
5. Remove second slotted screw.
6. While holding Allen wrench remove pin.
7. Turn Allen wrench clockwise to tighten or counter-clockwise to loosen tension to produce desired effect.
8. Re-insert pin in one of the two holes.
9. Tighten one slotted screw in the other hole (it may be necessary to turn Allen wrench slightly to align holes).
10. Remove pin and repeat step number 9 for other slotted screw.

SSK SOLID STATE CONTROL TEST INSTRUCTIONS

SSK Solid State Control (part number KE00458-1)

SWITCH	○	SWITCH - Push for 5 seconds to enter TEST #1 Press again for TEST #2 and again for TEST #3
CPU	○	CPU - Rapid flashing during normal operation TEST #1 = 1 flash/sec Water level test TEST #2 = 2 flash/sec Thermistor test TEST #3 = 3 flash/sec Heater Output test
DIAGNOSTIC LED	○	TEST #1 GREEN Probe senses water RED No water sensed
		TEST #2 GREEN Thermistor is sensed ORANGE Thermistor is shorted RED Thermistor is open circuit
POTENTIOMETER	○	LOW WATER
		HEATER OUTPUT
		TEST #3 GREEN voltage output to relay for 20 seconds. Normal operation LED matches Front heater (green) LED

THIS CONTROL BOX MUST BE CALIBRATED WHEN REPLACED
(see back for test and calibration instructions)

1. If required remove control box from holding bracket for better access.
 2. Turn unit on and set to 10 (maximum).
 3. Push and hold the SWITCH button for approximately 5 seconds until the CPU starts to flash 1 flash/second. You are now in TEST #1. Output to 12v relay is disabled. With kettle upright the DIAGNOSTIC LED should be green, with kettle tilted it should be red.
 4. Push SWITCH button. The CPU starts to flash 2 flash/second. You are now in TEST #2. Check the DIAGNOSTIC LED for indication of the temperature probe status.
 5. Push SWITCH button. The CPU starts to flash 3 flash/second. You are now in TEST #3. The HEATER OUTPUT LED should light for 20 seconds and power to the relay should energize the 12v relay for the heat source.
- After 20 seconds test mode is exited and unit reverts to normal operation.

SERVICE PARTS

WARRANTY

Our Company supports a worldwide network of Maintenance and Repair Centers. Contact your nearest Maintenance and Repair Centre for replacement parts, service, or information regarding the proper maintenance and repair of your cooking equipment

In order to preserve the various agency safety certification (UL, NSF, ASME/Ntl. Bd., etc.), only factory-supplied replacement parts should be used. The use of other than factory supplied replacement parts will void warranty.

FAUCET ASSEMBLY

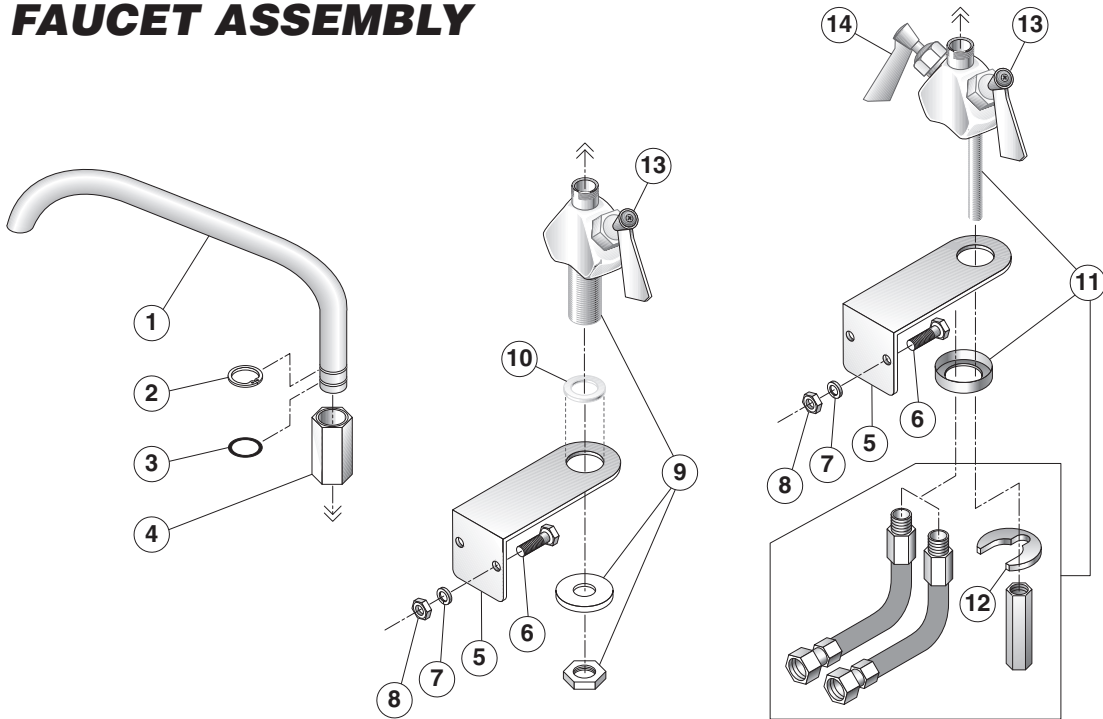

ITEM #	PART #	DESCRIPTION	QTY.
	SPK2	SINGLE PANTRY FAUCET for <u>KET20T</u> & <u>MKET12/20T</u> (includes items 1-10)	
	DPK2	DOUBLE PANTRY FAUCET for <u>KET20T</u> & <u>MKET12/20T</u> (includes items 1-8 & 11)	
	SPK9	SINGLE PANTRY FAUCET for <u>KET3/6/12T</u> (includes items 1-10)	
	DPK9	DOUBLE PANTRY FAUCET for <u>KET3/6/12T</u> (includes items 1-8 & 11)	
1.	KE50825-2 KE50825-9	3/4" SPOUT for - <u>SPK2</u> & <u>DPK2</u> 3/4" SPOUT for - <u>SPK9</u> & <u>DPK9</u>1 .1
2.	FA95007-10	RETAINING RING1
3.	FA05002-19	"O" RING1
4.	KE51736	LONG FAUCET NUT1
5.	KE54159 KE02071-1	FAUCET MOUNTING BRACKET PRISON FAUCET MOUNTING BRACKET1 .1
6.	FA11258	HEX CAP SCREW2
7.	FA31029	LOCK WASHER2
8.	FA21008	HEX NUT2
9.	KE51401	SINGLE PANTRY BODY (c/w item 13)1
10.	KE50335	ADAPTER WASHER1
11.	KE51403	DOUBLE PANTRY BODY (c/w item 13 & 14)1
12.	SE50447	REPLACEMENT HORSESHOE WASHER1
13.	SE50021	REPLACEMENT STEM ASSEMBLY, COLD WATER1
14.	SE50020	REPLACEMENT STEM ASSEMBLY, HOT WATER1

KETTLE BOTTOM & SIDE

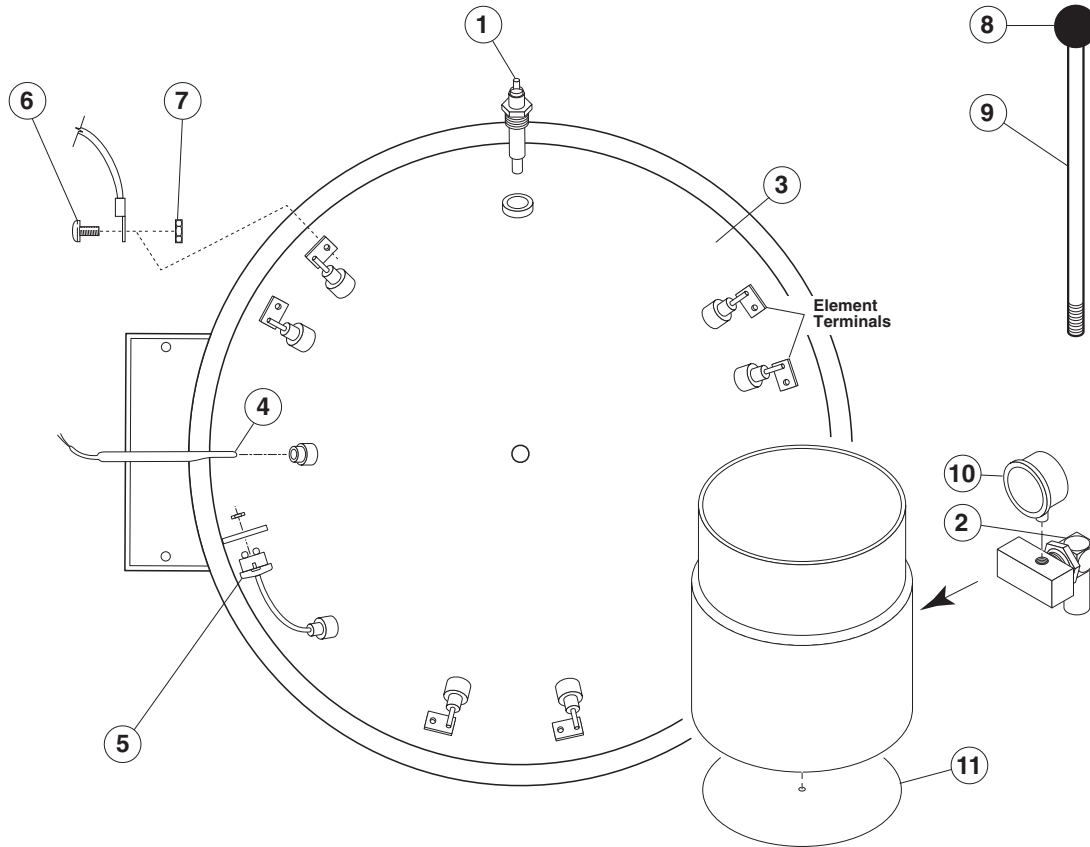

ITEM NO.	PART NO.	DESCRIPTION	QTY.
1.	KE50556-1	Probe, Low Water	1
2.	KE54941-6	Safety Valve, 50 PSI, 1/2" (North America)	1
	KE54941-31	Safety Valve, 50 PSI, 1/2", (Europe)	1
3.	KE55425-1	Bottom Cover Gasket, 3 gallon kettle	1
	KE55425-2	Bottom Cover Gasket, 6 gallon kettle	1
	KE55425-3	Bottom Cover Gasket, 12 gallon kettle	1
	KE55425-4	Bottom Cover Gasket, 20 gallon kettle	1
4.	KE00515	Thermistor Assembly	1
5.	KE55069-8	Safety Thermostat (140° C)	1
6.	FA11145	Screw	2-12
7.	FA21007	Nut	2-12
8.	KE50151-2	Knob	1
9.	KE54670-1	Handle, 3 & 6 gallon kettle	1
	KE54670-2	Handle, 12 gallon kettle	1
	KE54670-3	Handle, 20 gallon kettle	1
10.	KE50429-5	Pressure Guage	1
11.	KE52041	Bottom Cover, 3 gallon kettle	1
	KE603864-1	Bottom Cover, 6 gallon kettle	1
	KE603864-2	Bottom Cover, 12 gallon kettle	1
	KE603864-3	Bottom Cover, 20 gallon kettle	1
	KE54811	Bottom Cover, 12 gallon kettle, 380-480V	1

CONSOLE COMPONENTS & MARINE LOCK

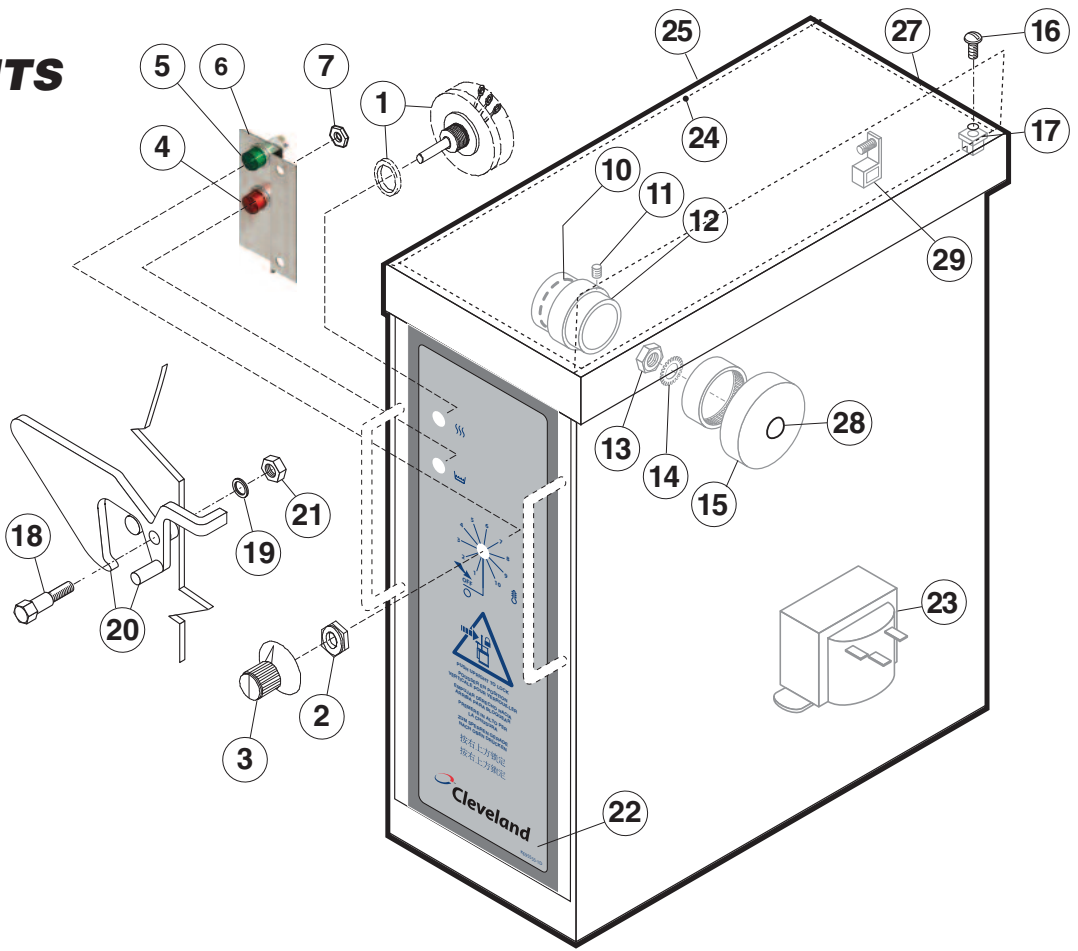

ITEM NO.	PART NO.	DESCRIPTION	QTY.
			Single / Twin
1.	SE00114	Potentiometer with ON/OFF Switch, c/w Item #2	1/2
2.	KE51005	Rubber Boot	1/2
3.	KE50569-1	Knob, Potentiometer	1/2
4.	KE55486-2	Indicator Light, Red	1/2
5.	KE55486-3	Indicator Light, Green	1/2
6.	KE603634	Bracket, Light	2/4
7.	FA21006	#10-24, Hex Nut, S.S.	4/8
10.	FA05002-20	"O" Ring	1/2
11.	FA19184	Allen Screw, #10	2/4
12.	SK50047-2	Collar, Trunnion Lock, KET, TKET	1/2
	SK50047-3	Collar, Trunnion Lock, TGB	1/2
13.	FA21024	Hex Nut, 5/16-18	1/2
14.	FA32027	Lockwasher	1/2
15.	KE01833	Bearing, KET-3-T, KET-20-T, TGB	1/2
	KE01834	Bearing, KET-6-T, KET-12-T, TGB	1/2
16.	FA95031	Screw	4
17.	FA95074	Nylon Anchor Nut	4
18.	FA15019-1	Hex Socket Shoulder Bolt	1/2
19.	FA31029	Split Lockwasher	1/2
20.	KE02078-1	Latch, Left Hand, KET	1
	KE02078-2	Latch, Right Hand, TKET	1
21.	FA21008	Hex Nut, 1/4-20	1/2
22.	KE95555-1	Label (KET-3-T, KET-6-T, KET-12-T, KET-20-T)	1
	KE95555-12	Label (KET-6-TGB, KET-12-TGB, KET-20-TGB)	1
	KE95555-3	Label (TKET-3-T)	1
	KE95555-4	Label (TKET-6-T, TKET-12-T)	1
23.	KE53838-11	Transformer, 380 to 415v	1
	KE53838-12	Transformer, 440 to 480v	1
24.	KE54846-1	Cover Gasket, KET- 3/6/12/20-T, TKET-3-T	1
	KE54846-2	Cover Gasket, TKET-6/12-T	1
25.	KE003688-1	Console Cover, (KET-3-T, KET-6-T, KET-12-T, KET-20-T)	1
	KE003688-2	Console Cover, (TKET-6-T, TKET-12-T)	1
28.	FA95073	Carriage Bolt	1
29.	KE50473	Ground Lug	1

TILTING GEARBOX ASSEMBLY

(6, 12 & 20 gallon kettles)

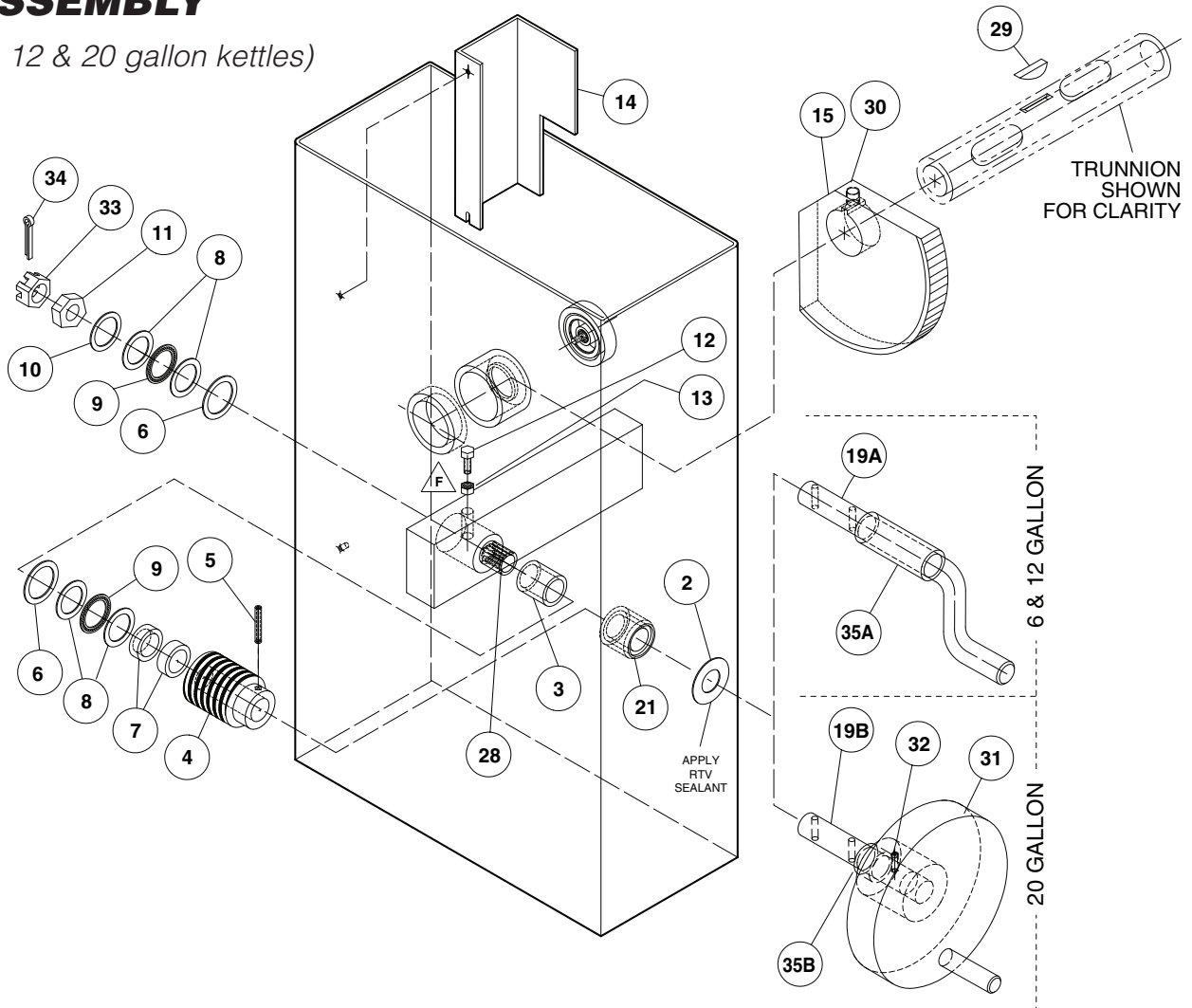

ITEM NO.	PART NO.	DESCRIPTION	QTY.
2.	KE54738-3	WASHER S.S. (SHAFT HOLE COVER)	1
3.	KE51738	BEARING SLEEVE FOR GEAR BOX	1
4.	KE50315	WORM GEAR	1
5.	FA95005	TENSION PIN	1
6.	KE51891	WASHER 1 1/2" O.D. X 13/16" I.D.	2
7.	KE52193-1	THRUST BEARING SPACER	2
8.	KE52192	THRUST WASHER	4
9.	KE52191	THRUST BEARING	2
10.	FA30088	TILT SHAFT WASHER	1
11.	FA95008	LOCK NUT 3/4-16	1
12.	FA19177	SET SCREW 5/16-24 X 1"	1
13.	FA20047	JAM HEX NUT 5/16-24	1
14.	KE54927	SUPPLY WIRE PROTECTION GUARD	1
15.	KE00151-2	SEGMENT GEAR	1
19A.	KE50306-2	TILT SHAFT (3, 6 & 12 GALLON)	1
19B.	KE50375-4	TILT SHAFT (20 GALLON)	1
21.	KE02057-4	TILT SHAFT BEARING ASSEMBLY	1
28.	KE50245	BEARING FOR GEARBOXES	1
29.	FA95083	WOODRUFF KEY #808	1
30.	FA19500-4	SET SCREW, 1/4-28 X 3/4	2
31.	KE00508	HANDWHEEL ASSEMBLY (INCLUDES #32)	1
32.	FA19505	SET SCREW 3/8-24 X 3/8	1
33.	KE55431	NUT, SLOTTED	1
34.	KE55432	COTTER PIN, 3/32 X 1 3/4	1
35A.	KE55433-1	SPACER, SAFETY (6 & 12 GALLON)	1
35B.	KE55433-2	SPACER, SAFETY (20 GALLON)	1

ELECTRICAL PANELS

ELECTRICAL PANEL ASSEMBLIES -

- KE00224-1 KET-3, 208-240V
- KE00224-2 KET12-TGB
- KE00224-3 TKET-3, 380-600V
- KE00224-4 KET-6/12/20, 208-240V
- KE00224-5 KET-6/12/20, 380-600V
- KE00224-6 TKET-12, 208-600V
- KE00224-7 TKET-12, 208-600V

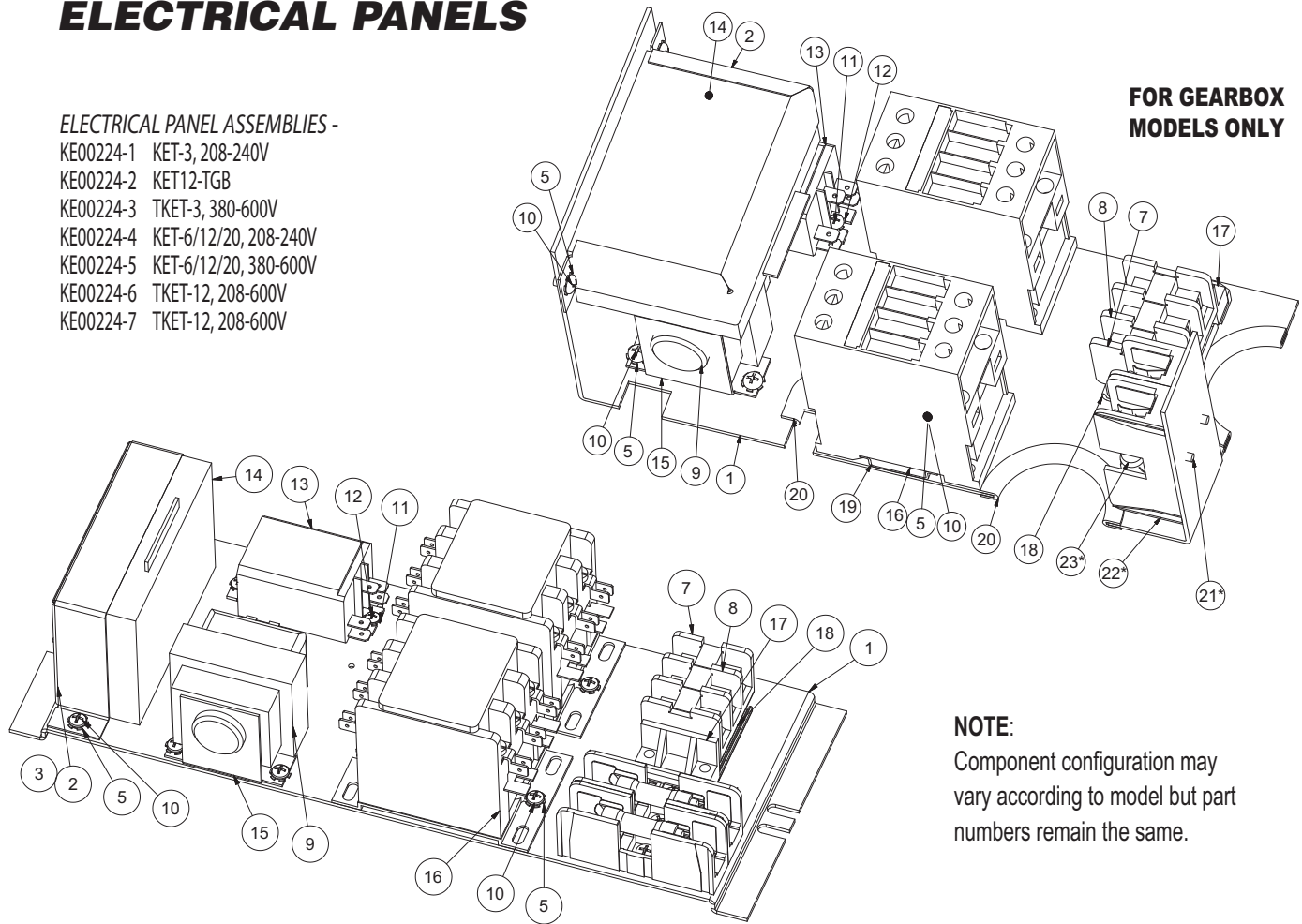

FOR GEARBOX MODELS ONLY

NOTE:

Component configuration may vary according to model but part numbers remain the same.

ITEM	PART #	DESCRIPTION	QTY
1	KE50343-1	COMPONENT PLATE	1
2	KE50303-2	ELECTRONIC BOX HOLDER	1
3	KE52548	ELECTRONIC BOX BRACKET (NOT SHOWN)	1
5	FA32005	TOOTH LOCK WASHER (PLATED) #8	10
6	FA10231	BINDING HEAD SCREW #6-32 x 1/4"LG (HIGH VOLTAGE)	2
7	SK50054-1	TERMINAL BLOCK; END SECTION	1
	SK50377	TERMINAL BLOCK; END SECTION, TKET-12-T, high wattage	1
8	SK50055-1	TERMINAL BLOCK	3
	SK50376	TERMINAL BLOCK; TKET-12-T, high wattage	3
9	KE53838-21	TRANSFORMER; 240P/16S 60HZ	1
10	FA10237	BINDING HEAD SCREW #8-32 x 1/4"LG	10
11	FA10135	BINDING HEAD SCREW #6-32 x 1/2"LG	2
12	FA32004	TOOTH LOCKWASHER (PLATED) #6	2
13	KE50753-7	RELAY	1
14	KE00458-1	ELECTRIC CONTROL BOX	1
15	KE53444	BRACKET TRANSFORMER	1
16	KE603902-2	CONTACTOR	2
17	SK50054-2	TERMINAL BLOCK; END ANCHOR	1
18	KE54761-1	TERMINAL BLOCK MTG. RAIL	1
19	KE51139-1	FUSE HOLDER 380-400V (HIGH VOLTAGE)	2
20	KE52936-1	FUSE 380-600V (HIGH VOLTAGE)	2

FOR GEARBOX MODELS ONLY

ITEM	QTY	PART NO.	DESCRIPTION
1	1	KE50343-17	COMPONENT PLATE
2	1	KE50303-2	ELECTRONIC BOX HOLDER
5	8	FA32005	TOOTH LOCKWASHER (PLATED) #8
7	1	SK50054-1	TERMINAL BLOCK; END SECTION
8	3	SK50055-1	TERMINAL BLOCK
9	1	KE53838-21	TRANSFORMER;240/16S 60HZ
10	8	FA10237	BINDING HEAD SCREW #8-32 x 1/4"LG
11	2	FA10131	BINDING HEAD SCREW #6-32 x 1/4"LG
12	2	FA32004	TOOTH LOCKWASHER (PLATED) #6
13	1	KE50753-7	RELAY; SPDT/10A/12VDC
14	1	KE00458-1	ELECTRIC CONTROL BOX - SOLID STATE
15	1	KE53444	BRACKET, TRANSFORMER
16	2	KE603902-9	CONTACTOR
17	1	SK50054-2	TERMINAL BLOCK; END ANCHOR
18	1	KE54761-1	TERMINAL BLOCK MTG. RAIL
19	1	KE55288-3	MOUNTING RAIL
20	9 in	RB01850	RUBBER GASCCKET
			* HIGH VOLTAGE OPTION (380-600V)
21	2	FA10231	BINDING HEAD SCREW #6-32 x 1/4"LG
22	2	KE51139-1	FUSE HOLDER
23	2	KE52936-1	FUSE

* HIGH VOLTAGE (380-600 V) OPTION PARTS

WIRING DIAGRAM

3 Gallon Kettles

200-240v

Single Phase Only

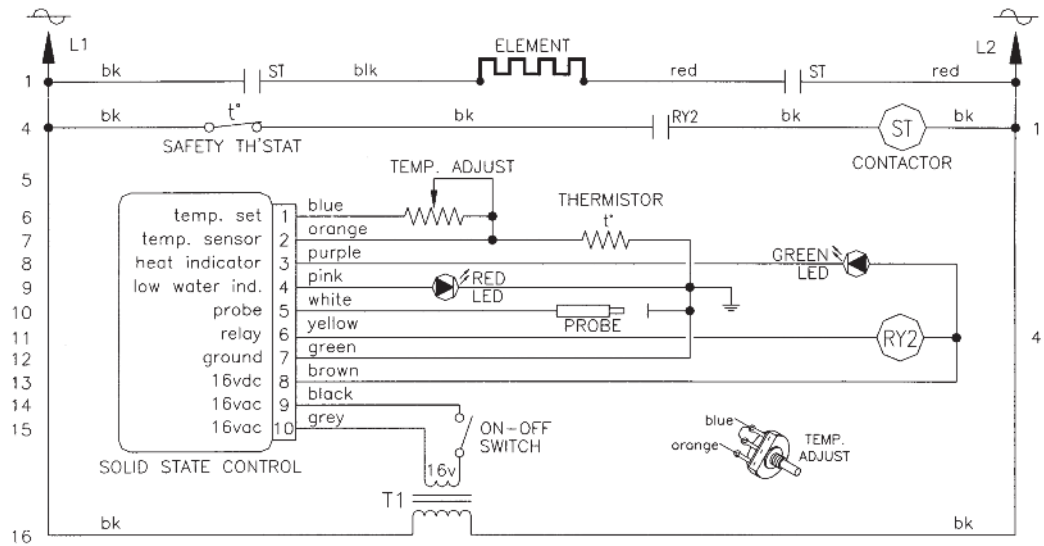

380-480v

Single Phase Only

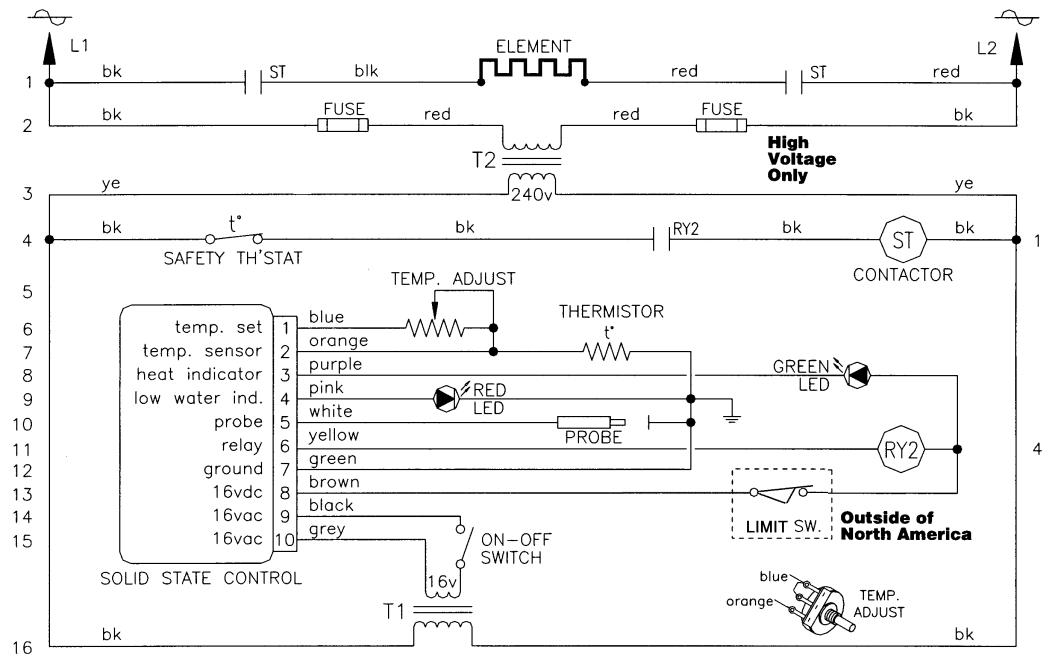

WIRING DIAGRAM

6-20 Gallon

200-240v

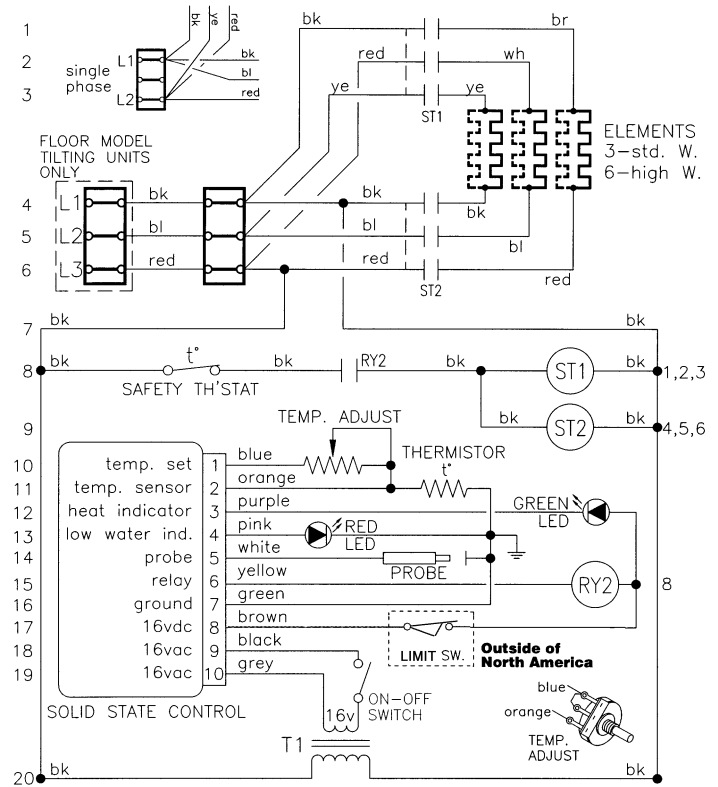

380-600v

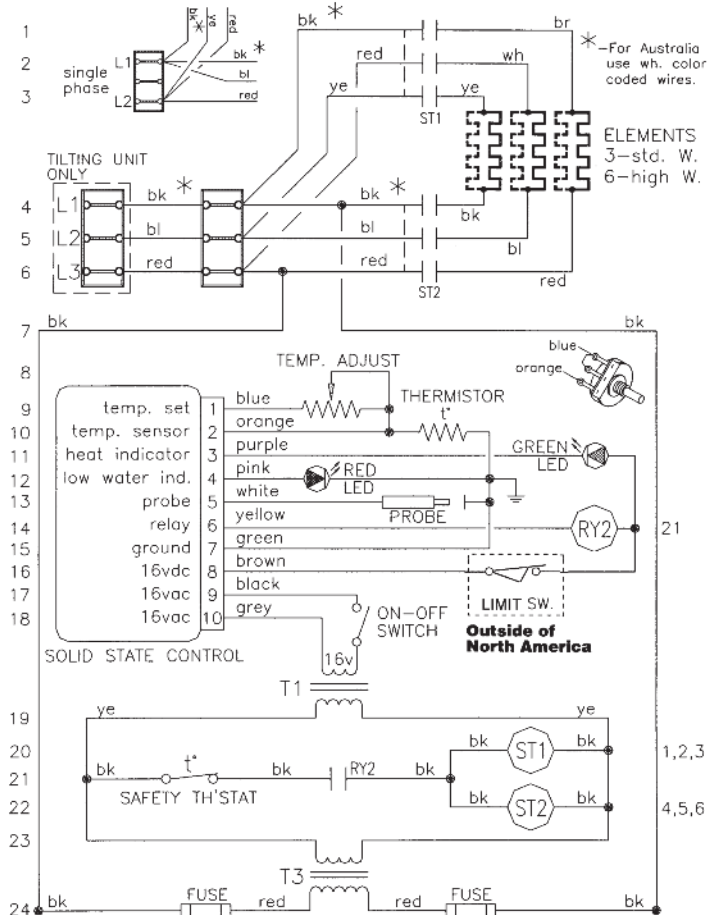

Every new piece of Welbilt Foodservice equipment comes with KitchenCare® and you choose the level of service that meets your operational needs from one restaurant to multiple locations

StarCare – Warranty & lifetime service, certified OEM parts, global parts inventory, performance audited

ExtraCare — CareCode, 24/7 Support, online/mobile product information

LifeCare – Install & equipment orientation, planned maintenance, KitchenConnect™, MenuConnect®

Talk with KitchenCare® • 1-844-724-CARE • www.mtwkitchencare.com



To learn how Welbilt Foodservice and its leading brands can equip you, visit our global web site at www.welbilt.com, then discover the regional or local resources available to you.